



# TEF6901A

Integrated car radio

Rev. 02 — 10 July 2006

Product data sheet

## 1. General description

The TEF6901A is a single chip car radio integrated circuit with FM/AM tuner, stereo decoder, weak signal processing and audio processing. Radio Data System (RDS)/Radio Broadcast Data System (RBDS) demodulator for radio data reception is included.

FM tuner with double conversion to IF1 = 10.7 MHz and IF2 = 450 kHz with integrated image rejection for both IF1 and IF2; integrated channel filter with variable bandwidth control; capable of US FM, Europe FM, Japan FM and Eastern Europe FM. AM tuner with double conversion to IF1 = 10.7 MHz and IF2 = 450 kHz; capable of Long Wave (LW), Medium Wave (MW) and full range Short Wave (SW) (11 m to 120 m bands).

Multiplex (MPX) stereo decoder, ignition noise blanker and extensive weak signal processing.

Audio processing with flexible source selection, volume, balance, fader, input gain control and inaudible tuning mute. Integrated audio filters for bass and treble and loudness control function.

The device can be controlled via the fast-mode I<sup>2</sup>C-bus (400 kHz) and includes autonomous tuning functions for easy control without microcontroller timing. No manual alignments are required.

## 2. Features

- FM Radio Frequency (RF) front-end with large dynamic range
- Integrated FM channel filter with controlled bandwidth
- Fully integrated FM demodulator
- Fully integrated stereo decoder with high immunity for birdy noise
- FM noise blanker with adaptive detection at MPX and level
- Signal quality detection: level, AM wideband, frequency deviation, ultrasonic noise/adjacent channel
- FM weak signal processing: stereo blend, high cut control and soft mute
- AM RF Automatic Gain Control (AGC) control circuit for external cascode AGC and PIN diode AGC
- Dual AM noise blanking system
- AM weak signal processing: high cut control and soft mute
- Low phase noise local oscillator
- In-lock detection for optimized adaptive Phase-Locked Loop (PLL) tuning speed
- Crystal oscillator reference with low harmonics
- Inaudible soft slope tuning mute for AM and FM
- Sequential state machine supporting each tuning action

# PHILIPS

- Integrated RDS/RBDS radio data demodulator
- Flexible audio input source selection
- Integrated audio processing and tone filtering
- Treble, bass and loudness tone control
- Volume, balance, fader and input gain control
- Audio controls with Audio Step Interpolation (ASI) for pop-free function
- Compact Disc (CD) dynamics compression
- Volume Unit (VU)-meter audio level read-out

### 3. Quick reference data

Table 1. Quick reference data

| Symbol                              | Parameter   | Conditions  | Min | Typ | Max  | Unit |
|-------------------------------------|---|---|-----|-----|------|------|
| <b>Supply voltage</b>               |   |   |     |     |      |      |
| V <sub>CC</sub>                     | analog supply voltage on pins VCC, VCCPLL, VCCVCO, VCCRF, AMMIX2OUT1, AMMIX2OUT2, MIX1OUT1 and MIX1OUT2 |   | 8   | 8.5 | 9    | V    |
| <b>Supply current in FM mode</b>    |   |   |     |     |      |      |
| I <sub>CC</sub>                     | total supply current inclusive I <sub>V60</sub>   |   | -   | 102 | -    | mA   |
| <b>Supply current in AM mode</b>    |   |   |     |     |      |      |
| I <sub>CC</sub>                     | total supply current inclusive I <sub>V60</sub>   |   | -   | 89  | -    | mA   |
| <b>AM overall system parameters</b> |   |   |     |     |      |      |
| f <sub>tune</sub>                   | AM tuning frequency   | LW  | 144 | -   | 288  | kHz  |
|                                     |   | MW  | 522 | -   | 1710 | kHz  |
|                                     |   | SW  | 2.3 | -   | 26.1 | MHz  |
| V <sub>sens</sub>                   | sensitivity voltage   | f <sub>RF</sub> = 990 kHz; m = 0.3; f <sub>mod</sub> = 1 kHz; B <sub>AF</sub> = 2.15 kHz; (S+N)/N = 26 dB; dummy aerial 15 pF/60 pF               | -   | 50  | -    | μV   |
| S/N                                 | ultimate signal-to-noise ratio  |   | 54  | 58  | -    | dB   |
| THD                                 | total harmonic distortion   | 200 μV < V <sub>RF</sub> < 1 V; m = 0.8; f <sub>AF</sub> = 400 Hz   | -   | 0.4 | 1    | %    |
| IP3                                 | 3rd-order intercept point   | Δf = 40 kHz   | -   | 130 | -    | dBμV |
| <b>FM overall system parameters</b> |   |   |     |     |      |      |
| f <sub>tune</sub>                   | FM tuning frequency   |   | 65  | -   | 108  | MHz  |
| V <sub>sens</sub>                   | sensitivity voltage (RF input voltage at (S+N)/N = 26 dB)   | Δf = 22.5 kHz; f <sub>mod</sub> = 1 kHz; DEMP = 1; B = 300 Hz to 22 kHz; measured with 75 Ω dummy antenna and test circuit                        | -   | 2   | -    | μV   |
| (S+N)/N                             | maximum signal plus noise-to-noise ratio of MPXAM output voltage  | V <sub>i</sub> = 3 mV; Δf = 22.5 kHz; f <sub>mod</sub> = 1 kHz; DEMP = 1; B = 300 Hz to 22 kHz; measured with 75 Ω dummy antenna and test circuit | -   | 60  | -    | dB   |
| THD                                 | total harmonic distortion   | Δf = 75 kHz   | -   | 0.5 | 1    | %    |
| IP3                                 | 3rd-order intercept point   | Δf = 400 kHz  | -   | 120 | -    | dBμV |

Table 1. Quick reference data ...continued

| Symbol                     | Parameter                   | Conditions   | Min | Typ  | Max | Unit |
|----------------------------|-----------------------------|--|-----|------|-----|------|
| <b>Stereo decoder path</b> |                             |  |     |      |     |      |
| $\alpha_{CS}$              | channel separation          | $f_{FMMPX} = 1 \text{ kHz}$  | 40  | -    | -   | dB   |
| S/N                        | signal-to-noise ratio       | $f_{MPXAMIN} = 20 \text{ Hz to } 15 \text{ kHz}$ ;<br>referenced to 1 kHz at 91 % FM<br>modulation; DEMP = 1                       | 70  | -    | -   | dB   |
| THD                        | total harmonic distortion   | FM mode; DEMP = 1; measured<br>with 15 kHz brick-wall low-pass<br>filter; $f_{MPXAMIN} = 200 \text{ Hz to } 15 \text{ kHz}$        | -   | -    | 0.3 | %    |
| <b>Tone/volume control</b> |                             |  |     |      |     |      |
| $V_{i(max)}$               | maximum input voltage       | THD = 0.2 %; $G_{vol} = -6 \text{ dB}$ ;<br>pins INAL, INAR, INAC, INBL,<br>INBR, INC and IND                                      | 2   | -    | -   | V    |
| THD                        | total harmonic distortion   | configured as non-inverting, single<br>ended inputs; $f_{audio} = 20 \text{ Hz to } 10 \text{ kHz}$ ;<br>$V_i = 1 \text{ V (RMS)}$ | -   | 0.02 | 0.1 | %    |
| $G_{vol}$                  | volume/balance gain control | see <a href="#">Table 83</a>   |     |      |     |      |
|                            |                             | maximum setting  | [1] | -    | 20  | - dB |
|                            |                             | minimum setting  | [1] | -    | -75 | - dB |
| $G_{step(vol)}$            | step resolution             |  | -   | 1    | -   | dB   |
| $G_{treble}$               | treble gain control         | TRE[2:0] = 111; TREM = 1   | -   | 14   | -   | dB   |
|                            |                             | TRE[2:0] = 111; TREM = 0   | -   | -14  | -   | dB   |
| $G_{step(treble)}$         | step resolution gain        |  | -   | 2    | -   | dB   |
| $G_{bass}$                 | bass gain control           | BAS[3:0] = 0111; BAM = 1   | -   | 14   | -   | dB   |
|                            |                             | BAS[3:0] = 0111; BAM = 0   | -   | -14  | -   | dB   |
| $G_{step(bass)}$           | step resolution gain        |  | -   | 2    | -   | dB   |

[1] The input gain setting ING and the volume setting VOL define the overall volume. The overall range is limited to -83 dB to +28 dB. For values > +28 dB the actual value is +28 dB. For overall values < -83 dB the actual value is mute.

## 4. Ordering information

Table 2. Ordering information

| Type number | Package |   | Version  |
|-------------|---------|---|----------|
|             | Name    | Description   |          |
| TEF6901AH   | QFP64   | plastic quad flat package; 64 leads (lead length 1.6 mm); body 14 × 14 × 2.7 mm | SOT393-1 |

5. Block diagram

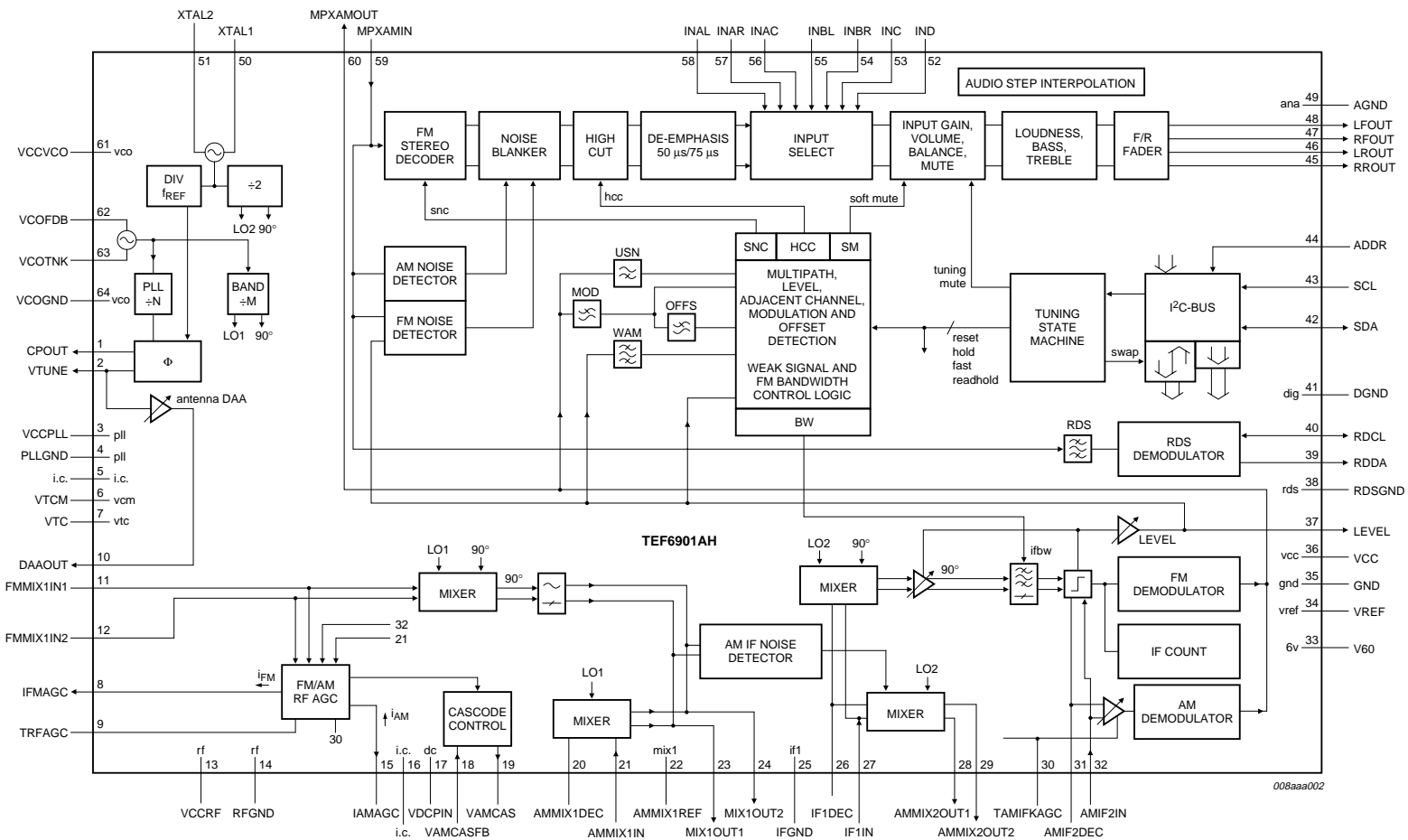

Fig 1. Block diagram of TEF6901AH

## 6. Pinning information

### 6.1 Pinning

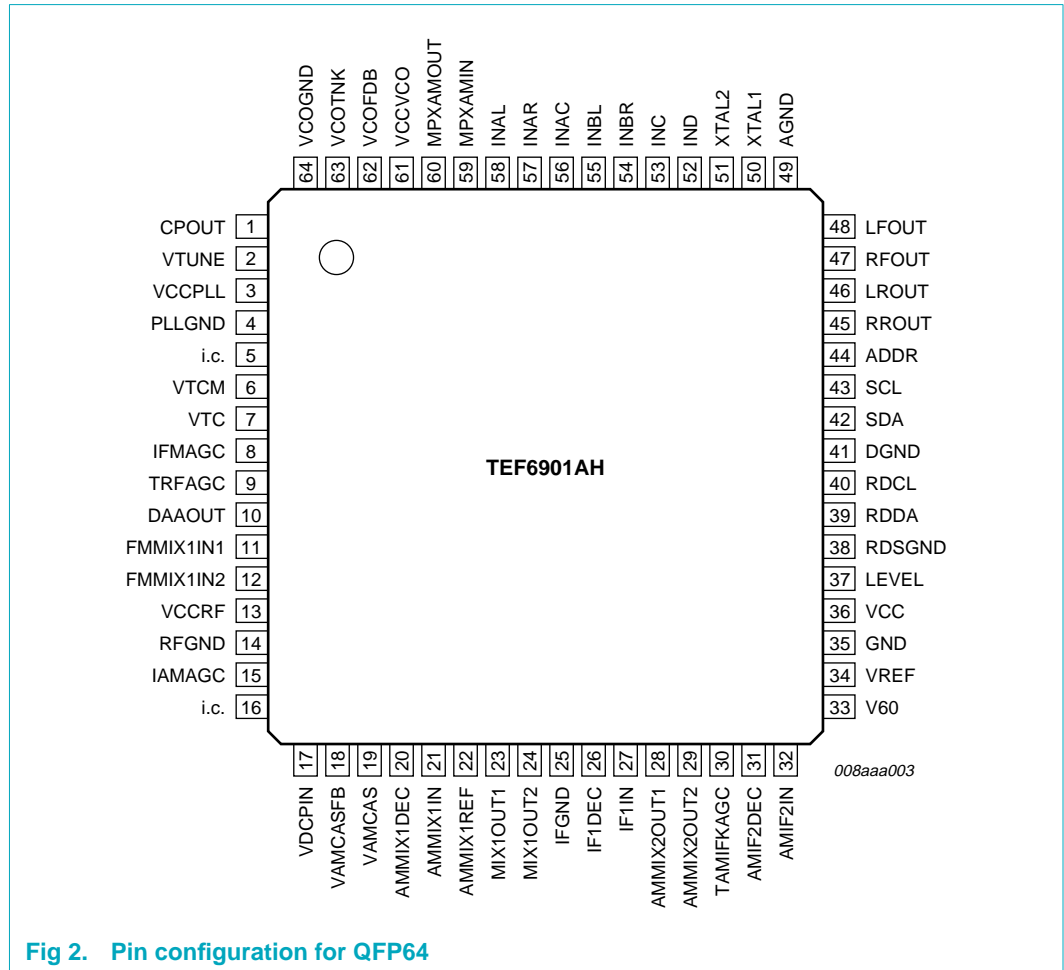

Fig 2. Pin configuration for QFP64

### 6.2 Pin description

Table 3. Pin description

| Symbol | Pin | Description  |
|--------|-----|--|
| CPOUT  | 1   | charge pump output                                   |
| VTUNE  | 2   | tuning voltage; 3 mA charge pump output              |
| VCCPLL | 3   | tuning PLL supply voltage                            |
| PLLGND | 4   | PLL ground   |
| i.c.   | 5   | internally connected; leave open                     |
| VTCM   | 6   | Intermediate Frequency (IF) filter reference voltage |
| VTC    | 7   | IF filter center voltage                             |
| IFMAGC | 8   | PIN diode current FM AGC                             |
| TRFAGC | 9   | FM and AM RF AGC time constant                       |
| DAAOUT | 10  | antenna Digital Auto Alignment (DAA) output          |

Table 3. Pin description ...continued

| Symbol     | Pin | Description   |
|------------|-----|---|
| FMMIX1IN1  | 11  | FM mixer 1 input 1                                      |
| FMMIX1IN2  | 12  | FM mixer 1 input 2                                      |
| VCCRF      | 13  | AM/FM RF supply voltage                                 |
| RFGND      | 14  | RF ground   |
| IAMAGC     | 15  | PIN diode current AMAGC                                 |
| i.c.       | 16  | internally connected; leave open                        |
| VDCPIN     | 17  | AM PIN diode DC bias voltage                            |
| VAMCASFB   | 18  | feedback for cascode AM AGC                             |
| VAMCAS     | 19  | cascode AM AGC  |
| AMMIX1DEC  | 20  | AM mixer 1 decoupling                                   |
| AMMIX1IN   | 21  | AM mixer 1 input  |
| AMMIX1REF  | 22  | AM mixer 1 reference                                    |
| MIX1OUT1   | 23  | AM and FM mixer 1 output 1 at IF1                       |
| MIX1OUT2   | 24  | AM and FM mixer 1 output 2 at IF1                       |
| IFGND      | 25  | IF ground   |
| IF1DEC     | 26  | AM and FM mixer 2 decoupling                            |
| IF1IN      | 27  | AM and FM mixer 2 input                                 |
| AMMIX2OUT1 | 28  | AM mixer 2 output 1 at IF2                              |
| AMMIX2OUT2 | 29  | AM mixer 2 output 2 at IF2                              |
| TAMIFKAGC  | 30  | AM IF AGC and FM keyed AGC time constant                |
| AMIF2DEC   | 31  | AM IF2 input decoupling                                 |
| AMIF2IN    | 32  | AM IF2 input  |
| V60        | 33  | input for FM filter and demodulator supply current      |
| VREF       | 34  | reference voltage for noise decoupling                  |
| GND        | 35  | ground  |
| VCC        | 36  | 8.5 V supply voltage                                    |
| LEVEL      | 37  | AM and FM level voltage output                          |
| RDSGND     | 38  | RDS ground  |
| RDDA       | 39  | RDS/RBDS demodulator data and quality output            |
| RDCL       | 40  | RDS/RBDS demodulator clock input or output              |
| DGND       | 41  | digital ground  |
| SDA        | 42  | I <sup>2</sup> C-bus Serial Data (SDA) input and output |
| SCL        | 43  | I <sup>2</sup> C-bus Serial Clock (SCL) input           |
| ADDR       | 44  | I <sup>2</sup> C-bus slave address select input         |
| RROUT      | 45  | right rear audio output                                 |
| LROUT      | 46  | left rear audio output                                  |
| RFOUT      | 47  | right front audio output                                |
| LFOUT      | 48  | left front audio output                                 |
| AGND       | 49  | analog ground   |
| XTAL1      | 50  | crystal oscillator 1                                    |
| XTAL2      | 51  | crystal oscillator 2                                    |

**Table 3.** Pin description ...continued

| Symbol   | Pin | Description   |
|----------|-----|---|
| IND      | 52  | audio input D, signal input                             |
| INC      | 53  | audio input C, common mode or signal input              |
| INBR     | 54  | audio input B, right channel                            |
| INBL     | 55  | audio input B, left channel                             |
| INAC     | 56  | audio input A, left channel inverted (or other options) |
| INAR     | 57  | audio input A, right channel                            |
| INAL     | 58  | audio input A, left channel                             |
| MPXAMIN  | 59  | MPX and AM audio input to radio processing              |
| MPXAMOUT | 60  | MPX and AM audio output from tuner part                 |
| VCCVCO   | 61  | Voltage-Controlled Oscillator (VCO) supply voltage      |
| VCOFDB   | 62  | VCO feedback  |
| VCOTNK   | 63  | VCO tank circuit  |
| VCOGND   | 64  | VCO ground  |

## 7. Functional description

### 7.1 FM mixer 1

The FM quadrature mixer 1 converts FM RF (65 MHz to 108 MHz) to an IF frequency of 10.7 MHz. The FM mixer provides image rejection and a large dynamic range. Low and high injection Local Oscillator (LO) can be selected via the I<sup>2</sup>C-bus.

### 7.2 FM RF AGC

AGC detection at the FM front-end mixer input with programmable threshold. When the threshold is exceeded, the PIN diode drive circuit sources a current to an external PIN diode circuit, keeping the RF signal level constant. Keyed AGC function is selectable via the I<sup>2</sup>C-bus and uses the in-band level information derived from the limiter. The AGC PIN diode drive circuit can optionally deliver a fixed current; this local mode can be used for search tuning on absolute RF levels. In AM mode, the FM AGC PIN diode drive circuit can be set to source a fixed current into the external FM PIN diode circuitry.

### 7.3 FM mixer 2

The FM quadrature mixer 2 converts 10.7 MHz IF1 to 450 kHz IF2 and includes image rejection with the integrated channel filter. Two gain settings can be selected to compensate for high ceramic filter insertion loss.

### 7.4 FM IF2 channel filter

The order and dynamic range of the FM IF2 channel filter is designed for operation with only one external ceramic filter. The filter characteristic is optimized to combine high selectivity with low distortion. The bandwidth of the filter can be set to a range of fixed settings or automatically via the bandwidth control algorithm. When the automatic mode is selected the bandwidth depends on the signal conditions.

### 7.5 FM limiter and level detection

The limiter amplifies the IF filter output signal, removes AM modulations from the IF signal and supplies a well defined signal for the FM demodulator. From the limiter also the Radio Signal Strength Information (RSSI) is derived which is converted to a suitable level voltage with minimum temperature drift.

### 7.6 FM demodulator

The fully integrated FM demodulator converts the IF signal from the limiter to the FM multiplex output signal with low distortion.

### 7.7 Center frequency and bandwidth tuning and center frequency DAA

The center frequency as well as the bandwidth of both the IF filter and demodulator are coupled to the crystal reference frequency. A coarse alignment (IFCAP) sets the circuit operating range and the center frequency fine adjustment is achieved with a 6-bit alignment (IFCF).

### 7.8 Bandwidth control algorithm

The bandwidth of the IF filter can be selected with 5 bits, directly via I<sup>2</sup>C-bus or automatically via the bandwidth control algorithm. The bandwidth control algorithm detects the amount of adjacent channel interference, the deviation of the desired signal, detuning, multipath and signal strength to define the optimum bandwidth setting of the IF filter. Flexibility on the algorithm settings is provided via the I<sup>2</sup>C-bus control.

### 7.9 VCO and dividers

The varactor tuned LC oscillator together with the dividers provides the local oscillator signal for both AM and FM front-end mixers. The VCO has an operating frequency of approximately 160 MHz to 250 MHz. In FM mode the VCO frequency is divided by 2 or 3. These dividers generate in-phase and quadrature-phase output signals used in the FM front-end mixer for image rejection. In AM mode the VCO frequency is divided by 6, 8, 10, 16 or 20 depending on the selected AM band. The amplitude of the VCO is controlled by a digital AGC to ensure a safe oscillation start-up at a wide range of the loaded Q.

### 7.10 Crystal oscillator

The crystal oscillator provides a 20.5 MHz signal. A divider-by-two generates in-phase and quadrature-phase mixer frequencies for the conversion from IF1 to IF2 including image rejection. The reference divider generates from the crystal frequency various reference frequencies for the tuning PLL. Also timing signals for the sequential machine as well as references for the integrated FM channel filter, the stereo decoder and the integrated audio filters and the RDS demodulator are derived from the crystal reference.

### 7.11 Tuning PLL

The tuning PLL locks the VCO frequency divided by the programmable divider ratio to the reference frequency. Due to the combination of different charge pump signals in the PLL loop filter, the loop parameters are adapted dynamically. Tuning to different RF frequencies is done by changing the programmable divider ratio. The tuning step size is selected with the reference frequency divider setting.



### 7.12 Antenna DAA

For FM operation the antenna Digital Auto Alignment (DAA) measures the VCO tuning voltage and multiplies it with a factor defined by the 7-bit DAA setting to generate a tuning voltage for the FM antenna tank circuit (RF selectivity). In AM mode the DAA setting controls a fixed voltage.

### 7.13 AM RF AGC control

The AM front-end is designed for the application of an external Junction Field Effect Transistor (JFET) low noise amplifier with cascode AGC and PIN diode AGC both controlled by an integrated AGC control circuit. Four AGC thresholds of the detector at the first mixer input are selectable via I<sup>2</sup>C-bus. Detectors at the RF mixer input and at the AMIF2 input prevent undesired overload (see [Figure 40](#)). AGC information can be read out via I<sup>2</sup>C-bus. The PIN diode current drive circuit includes a pull-up current source for reverse biasing of the PIN diode, when the AGC is not active to achieve a low parasitic capacitance.

### 7.14 AM mixer 1

The large dynamic range AM mixer converts AM RF (144 kHz to 26.1 MHz) to an IF frequency of 10.7 MHz.

### 7.15 AM IF noise blanker

The spike detection for the AM IF noise blanker is at the output of the AM front-end mixer. Blanking is realized at the second AM mixer.

### 7.16 AM IF AGC amplifier and demodulator

The 450 kHz IF2 signal after the ceramic channel selection filter is amplified by the IF AGC amplifier and demodulated.

### 7.17 AM level detection

The IF2 signal used for AM IF AGC and demodulation is also used in the limiter circuit for in-band level detection.

### 7.18 AM and FM level DAA

The start and slope of the level detector output are programmable to achieve level information independent on gain spread in the signal channel.

### 7.19 AM and FM IF counter

The output signal from the limiter is used for IF counting in both AM and FM.

### 7.20 Tuning mute

A soft slope tuning mute is controlled by the sequential machine for different tuning actions to eliminate audible effects of tuning and band switching.

### 7.21 FM stereo decoder

A low-pass filter provides additional suppression of high frequency interferences at the stereo decoder input and the necessary signal delay for FM noise blanking.

The MPX signal is decoded in the stereo decoder part. An integrated oscillator and pilot PLL is used for the regeneration of the 38 kHz subcarrier. The required 19 kHz and 38 kHz signals are generated by division of the oscillator output signal in a logic circuitry.

By means of a 19 kHz quadrature detector the pilot PLL oscillator frequency is locked to the incoming 19 kHz stereo pilot. A pilot level voltage derived from a 19 kHz in-phase detector is used for stereo detection and for generation of an anti-phase 19 kHz signal to remove the pilot tone from the audio signal.

The signal is then decoded in the decoder part. The L-R side signal is demodulated using the 38 kHz subcarrier and combined with the main signal to the left and right audio channel. A fine adjustment is done by adjusting the gain of the L-R signal. A smooth mono to stereo takeover is achieved by controlling the efficiency of the matrix by the SNC signal from the weak signal processing block.

### 7.22 FM and AM AF noise blanker

The FM or AM tuner operation selects between two noise blanker operations optimized for FM or AM ignition noise suppression.

In FM mode the noise blanker operates as a modified sample and hold circuit with ultrasonic noise detection on MPX and detection of noise spikes on level.

In AM mode the audio signal is muted during the interference pulse triggered by slew-rate detection of the audio signal.

### 7.23 Fixed high cut and high cut control

The high cut part is a low-pass filter circuit with seven bandwidth settings. The cut-off frequencies of the filter curves can be selected to match different application requirements (fixed high cut).

The high cut circuit also provides a dynamic control of the filter response, the High Cut Control (HCC). This function is controlled by the HCC signal from the weak signal processing.

### 7.24 De-emphasis

The signal passes the low-pass filter de-emphasis block and is then fed to the source selector. The de-emphasis time constant can be selected between the standards of 50  $\mu$ s and 75  $\mu$ s.

### 7.25 Weak signal processing

The weak signal processing block detects quality degradations in the incoming signal and controls the processing of the audio signal accordingly. The weak signal processing block has three different quality criteria: The average value of the level voltage, AM components on the level voltage (WAM = wideband AM) and high frequency components in the MPX signal (USN = ultrasonic noise).

In the weak signal processing block these signals are combined in specific ways and used for the generation of control signals for soft mute, stereo blend (stereo noise control, SNC) and HCC. Detector time constants of soft mute, HCC and SNC can be selected independently.

In AM mode soft mute and HCC are controlled by the average value of the level voltage.

## 7.26 Audio step interpolation

The tone/volume blocks of source selector, volume/balance, bass/loudness, fader and output mute include the Audio Step Interpolation (ASI) function. This minimizes audible pops by smoothing the transitions in the audio signal during the switching of the controls.

## 7.27 Source selector

The source selector selects one out of several input sources:

- One internal stereo signal (AM/FM tuner)
- Seven input pins allow many combinations of external sources by means of flexible input selection

Three of the seven input pins can connect to:

- 1 stereo signal with ground input for common mode rejection (CD)
- 1 stereo signal and 1 mono signal

Four more input pins can connect to:

- 1 stereo signal (AUX) and 1 mono signal with common mode rejection or differential input (PHONE)
- 1 stereo signal (AUX) and 2 mono signals (e.g. NAV and BEEP)
- 2 stereo signals (AUX and AUX-2)
- 1 stereo signal with common mode rejection (CD-2) and 1 mono signal (e.g. BEEP)
- 1 stereo signal with differential input (CD-symmetrical)

## 7.28 VU-meter read

The input audio level of external sources can read out via the I<sup>2</sup>C-bus. Audio level information is available on a logarithmic scale. In radio mode the AM or FM modulation index is available in the same way.

## 7.29 Volume and balance

The volume/balance control is used for volume setting and also for balance adjustment. The control range of the volume/balance control is between +20 dB and –75 dB in steps of 1 dB.

## 7.30 CD compression

Dynamic volume compression is available for external input sources. This option is generally used for audio from CD or other digital formats to reduce the very high dynamic range of these signals into a range suitable for the car environment.

**7.31 Bass**

The bass tone control stage controls the low audio frequencies with a modified shelf curve response. The control range is between +14 dB and -14 dB in steps of 2 dB. Four different filter cut-off frequencies can be selected.

**7.32 Treble**

The treble tone control stage controls the high audio frequencies with a shelf curve response. The control range is between +14 dB and -14 dB in steps of 2 dB. Four different filter cut-off frequencies can be selected.

**7.33 Loudness**

An integrated loudness function can be activated which controls bass and treble in relation to the user volume setting. The control range of the bass frequencies is limited to 20 dB and the optional treble range to 4 dB. Different volume ranges can be selected for the loudness control.

**7.34 Fader**

The fader is located at the end of the tone/volume chain. The balance between the front and rear channel can be controlled by attenuation of either the front or the rear channel. Control range is 0 dB to -64 dB with a step size of 1 dB. Optionally the fader attenuation can be activated for front and rear channels together.

**7.35 RDS/RBDS demodulator**

The RDS demodulator recovers and regenerates the continuously transmitted RDS or RBDS data stream that may be part of the FM MPX signal and provides the signals clock (RDCL) and data (RDDA) for further processing by a hardware or software RDS decoder. Unbuffered demodulator output and buffered 16-bit output mode are available. The output modes are compatible with stand-alone demodulator devices as well as digital and analog signal processor standards. In case of buffered output mode additional RDS Quality (RDQ) demodulation quality information is available optional.

**8. I<sup>2</sup>C-bus protocol**

SDA and SCL HIGH and LOW internal thresholds are specified according to both 2.5 V and 3.3 V I<sup>2</sup>C-bus, however also SDA and SCL signals from a 5 V bus are supported. The maximum I<sup>2</sup>C-bus communication speed is 400 kbit/s in accordance with the I<sup>2</sup>C-bus fast mode specification.

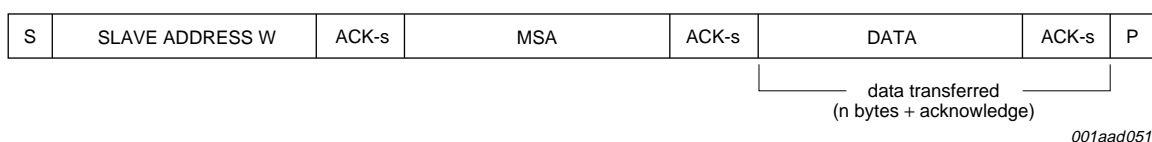

**Fig 3. Write mode**

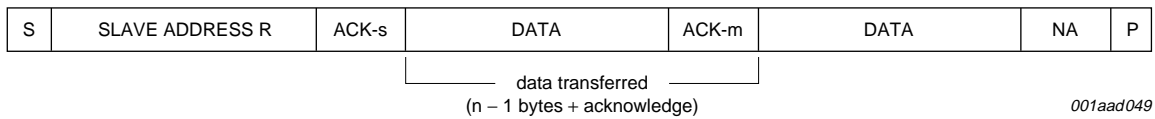

Fig 4. Read mode

Table 4. Description of I<sup>2</sup>C-bus format

| Code            | Description  |
|-----------------|--|
| S               | START condition  |
| Slave address W | 1100 0000b for pin ADDR grounded<br>1100 0010b for pin ADDR floating |
| Slave address R | 1100 0001b for pin ADDR grounded<br>1100 0011b for pin ADDR floating |
| ACK-s           | acknowledge generated by the slave                                   |
| ACK-m           | acknowledge generated by the master                                  |
| NA              | not acknowledge generated by the master                              |
| MSA             | mode and subaddress byte   |
| Data            | data byte  |
| P               | STOP condition   |

### 8.1 Read mode

**Application restriction to use the read mode:** Read transmissions should not be stopped after read byte 4 (IFBW) since this will disturb level read-out, weak signal processing and bandwidth control. Read transmission can be stopped after any of the other read bytes 0 to 3, 5 or 6.

The read data is loaded into the I<sup>2</sup>C-bus output register at the ACK clock pulse preceding the data byte.

Table 5. Read register overview

| Data byte | Name      | Reference                     |
|-----------|-----------|-------------------------------|
| 0         | IFCOUNTER | <a href="#">Section 8.1.1</a> |
| 1         | LEVEL     | <a href="#">Section 8.1.2</a> |
| 2         | USN/WAM   | <a href="#">Section 8.1.3</a> |
| 3         | MOD       | <a href="#">Section 8.1.4</a> |
| 4         | IFBW      | <a href="#">Section 8.1.5</a> |
| 5         | ID        | <a href="#">Section 8.1.6</a> |
| 6         | TEMP      | <a href="#">Section 8.1.7</a> |

8.1.1 Read mode: data byte IFCOUNTER

Table 6. IFCOUNTER - format of data byte 0

|       |       |      |      |      |      |      |      |
|-------|-------|------|------|------|------|------|------|
| 7     | 6     | 5    | 4    | 3    | 2    | 1    | 0    |
| IFCM1 | IFCM0 | IFCS | IFCA | IFC3 | IFC2 | IFC1 | IFC0 |

Table 7. IFCOUNTER - data byte 0 bit description

| Bit     | Symbol    | Description   |
|---------|-----------|---|
| 7 and 6 | IFCM[1:0] | IF counter mode; IFCM reads 00 immediately after I <sup>2</sup> C-bus start of PRESET, SEARCH, AFU, JUMP or CHECK until the first IFC result of the new tuning is available.<br><br>00 = no new counter result available (IFC value is previous result or reset state)<br><br>01 = new counter result available (IFC value is new result)<br><br>10 = counter result from AF update (IFC value is AF result, value is held until I <sup>2</sup> C-bus read). Also the detector information of LEV, USN, WAM and MOD shows AF update results.<br><br>11 = Power-On Reset (POR) or undefined state of the state machine is detected. The I <sup>2</sup> C-bus data is reset to POR state. |
| 5       | IFCS      | IF counter sign<br><br>0 = the IF counter result indicates a positive <b>RF</b> frequency error<br><br>1 = the IF counter result indicates a negative <b>RF</b> frequency error   |
| 4       | IFCA      | IF counter accuracy<br><br>0 = IF counter result with 1 kHz resolution in FM mode and 0.5 kHz resolution in AM mode<br><br>1 = IF counter result with 8 kHz resolution in FM mode and 4 kHz resolution in AM mode   |
| 3 to 0  | IFC[3:0]  | IF counter result; see <a href="#">Table 8</a>  |

Table 8. IF counter result

| IFC3 | IFC2 | IFC1 | IFC0 | Deviation from nominal value in FM |                   | Deviation from nominal value in AM |                  |
|------|------|------|------|------------------------------------|-------------------|------------------------------------|------------------|
|      |      |      |      | IFCA = 0                           | IFCA = 1          | IFCA = 0                           | IFCA = 1         |
| 0    | 0    | 0    | 0    | 0 kHz to 1 kHz                     | reset state       | 0 kHz to 0.5 kHz                   | reset state      |
| 0    | 0    | 0    | 1    | 1 kHz to 2 kHz                     | -                 | 0.5 kHz to 1 kHz                   | -                |
| 0    | 0    | 1    | 0    | 2 kHz to 3 kHz                     | 16 kHz to 24 kHz  | 1 kHz to 1.5 kHz                   | 8 kHz to 12 kHz  |
| 0    | 0    | 1    | 1    | 3 kHz to 4 kHz                     | 24 kHz to 32 kHz  | 1.5 kHz to 2 kHz                   | 12 kHz to 16 kHz |
| 0    | 1    | 0    | 0    | 4 kHz to 5 kHz                     | 32 kHz to 40 kHz  | 2 kHz to 2.5 kHz                   | 16 kHz to 20 kHz |
| 0    | 1    | 0    | 1    | 5 kHz to 6 kHz                     | 40 kHz to 48 kHz  | 2.5 kHz to 3 kHz                   | 20 kHz to 24 kHz |
| 0    | 1    | 1    | 0    | 6 kHz to 7 kHz                     | 48 kHz to 56 kHz  | 3 kHz to 3.5 kHz                   | 24 kHz to 28 kHz |
| 0    | 1    | 1    | 1    | 7 kHz to 8 kHz                     | 56 kHz to 64 kHz  | 3.5 kHz to 4 kHz                   | 28 kHz to 32 kHz |
| 1    | 0    | 0    | 0    | 8 kHz to 9 kHz                     | 64 kHz to 72 kHz  | 4 kHz to 4.5 kHz                   | 32 kHz to 36 kHz |
| 1    | 0    | 0    | 1    | 9 kHz to 10 kHz                    | 72 kHz to 80 kHz  | 4.5 kHz to 5 kHz                   | 36 kHz to 40 kHz |
| 1    | 0    | 1    | 0    | 10 kHz to 11 kHz                   | 80 kHz to 88 kHz  | 5 kHz to 5.5 kHz                   | 40 kHz to 44 kHz |
| 1    | 0    | 1    | 1    | 11 kHz to 12 kHz                   | 88 kHz to 96 kHz  | 5.5 kHz to 6 kHz                   | 44 kHz to 48 kHz |
| 1    | 1    | 0    | 0    | 12 kHz to 13 kHz                   | 96 kHz to 104 kHz | 6 kHz to 6.5 kHz                   | 48 kHz to 52 kHz |

Table 8. IF counter result ...continued

| IFC3 | IFC2 | IFC1 | IFC0 | Deviation from nominal value in FM |                    | Deviation from nominal value in AM |                  |
|------|------|------|------|------------------------------------|--------------------|------------------------------------|------------------|
|      |      |      |      | IFCA = 0                           | IFCA = 1           | IFCA = 0                           | IFCA = 1         |
| 1    | 1    | 0    | 1    | 13 kHz to 14 kHz                   | 104 kHz to 112 kHz | 6.5 kHz to 7 kHz                   | 52 kHz to 56 kHz |
| 1    | 1    | 1    | 0    | 14 kHz to 15 kHz                   | 112 kHz to 120 kHz | 7 kHz to 7.5 kHz                   | 56 kHz to 60 kHz |
| 1    | 1    | 1    | 1    | 15 kHz to 16 kHz                   | ≥ 120 kHz          | 7.5 kHz to 8 kHz                   | ≥ 60 kHz         |

After a tuning action, which is activated by the state machine, the IF counter is reset at that moment when tuning is established (PLL in-lock). The first counter result is available from 2 ms after reset. For FM further results can be obtained from 4 ms, 8 ms, 16 ms and 32 ms after reset, the increasing count time attenuates influence of FM modulation on the counter result. After this, the counter continues at the maximum count time of 32 ms (see Figure 5). For AM the count time is fixed to 2 ms and results are available every 2 ms.

After AF Update (AFU) sampling the IF counter read value is held (IFCM = 10) (see Figure 6, Figure 17 and Figure 18) for easy I<sup>2</sup>C-bus read-out. The counter itself remains active in the background in 2 ms count time mode. The IF counter data hold is released after I<sup>2</sup>C-bus read.

IFCM reads 00 immediately after I<sup>2</sup>C-bus start of PRESET, SEARCH, AFU, JUMP or CHECK until the first new tuning IFC result is available.

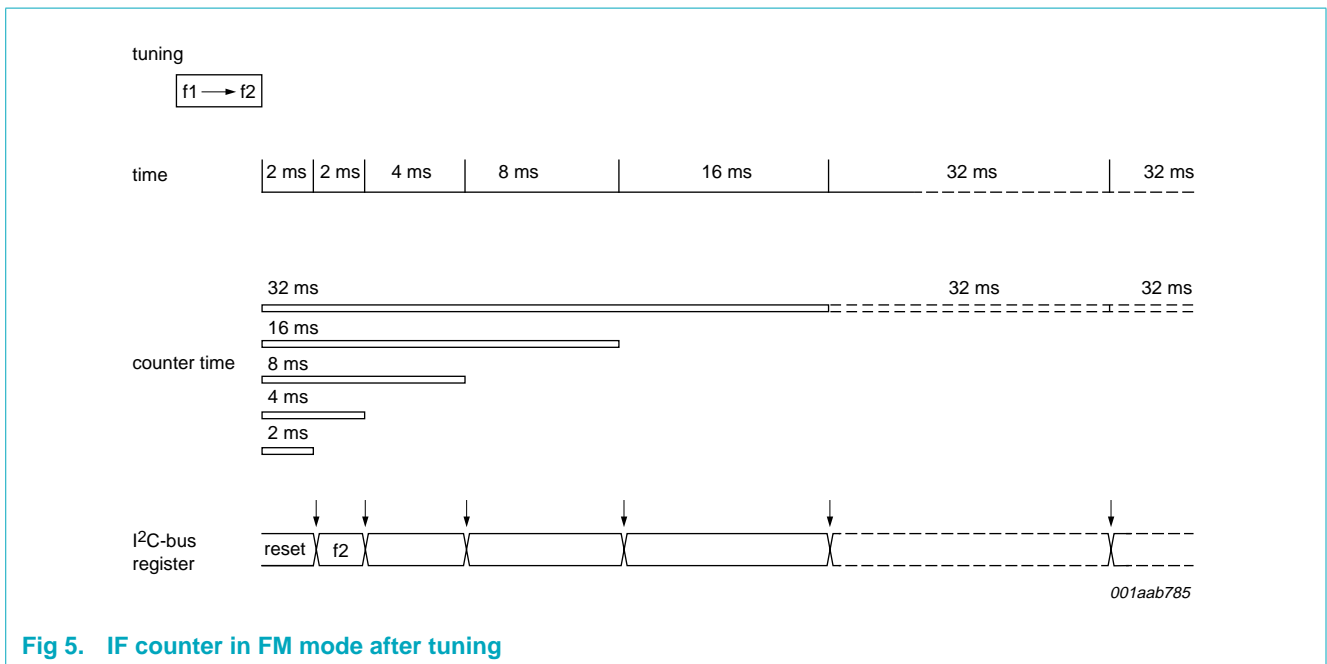

Fig 5. IF counter in FM mode after tuning

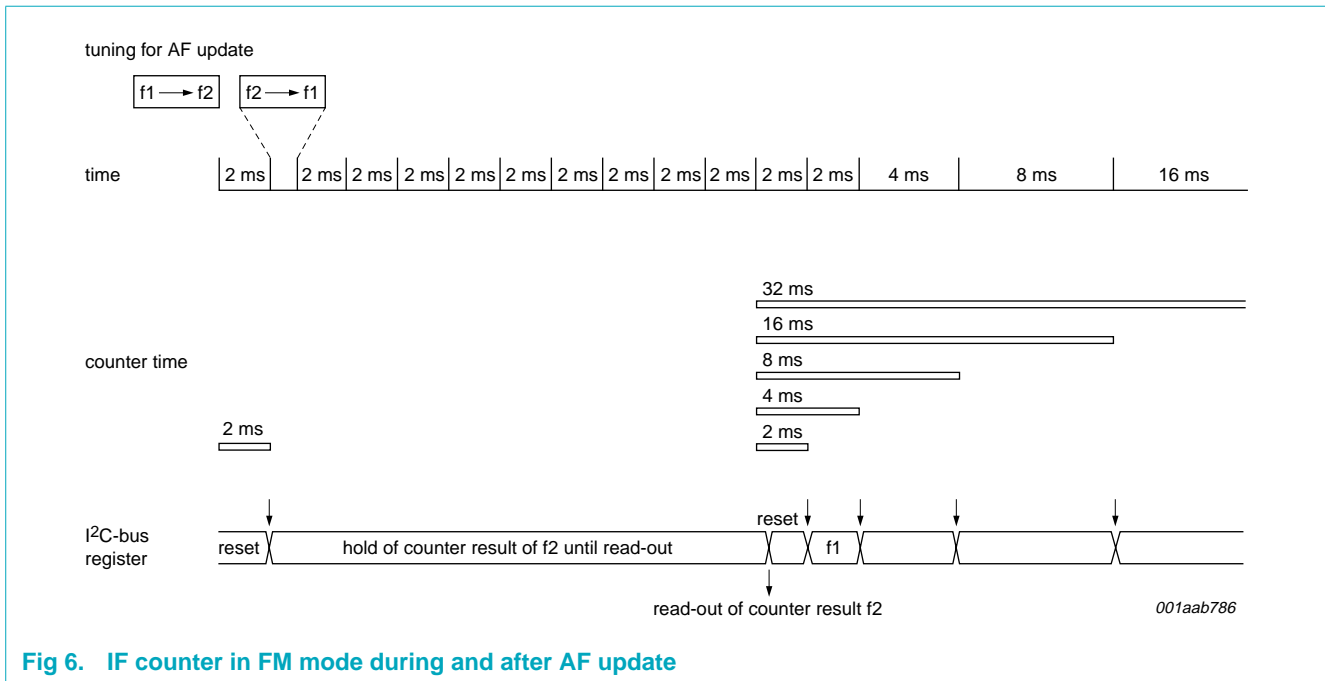

Fig 6. IF counter in FM mode during and after AF update

### 8.1.2 Read mode: data byte LEVEL

Table 9. LEVEL - format of data byte 1

|      |      |      |      |      |      |      |      |
|------|------|------|------|------|------|------|------|
| 7    | 6    | 5    | 4    | 3    | 2    | 1    | 0    |
| LEV7 | LEV6 | LEV5 | LEV4 | LEV3 | LEV2 | LEV1 | LEV0 |

Table 10. LEVEL - data byte 1 bit description

| Bit    | Symbol   | Description   |
|--------|----------|---|
| 7 to 0 | LEV[7:0] | level detector; this byte indicates the LEVEL voltage between 0.25 V (LEV = 0) and 4.25 V (LEV = 255) from the tuner part; $V_{LEVEL} = \frac{1}{64}LEV[7:0] + 0.25 V$ ; see <a href="#">Figure 7</a> |

After AF update sampling the level read value is held (indicated by IFCM = 10) for easy I<sup>2</sup>C-bus read-out. The level detector remains active in the background. The LEV data hold is released after I<sup>2</sup>C-bus read.

To reduce the influence of modulation in AM mode the LEV information is additionally filtered by a slow 60 ms detector. Fast level information is made available during AF update and check tuning.

For standard operation the following level alignment (byte LEVELALGN; see [Table 43](#)) is used:

FM and AM level slope;  $\Delta LEV = 51$  ( $\Delta V_{LEVEL} = 0.80 V$ ) at  $\Delta V_{RF} = 20 dB$  (measured at  $V_{RF} = 200 \mu V$  and  $V_{RF} = 20 \mu V$ )

FM mode level start; LEV = 78 ( $V_{LEVEL} = 1.47 V$ ) at  $V_{RF} = 20 \mu V$

AM mode level start; LEV = 63 ( $V_{LEVEL} = 1.24 V$ ) at  $V_{RF} = 20 \mu V$



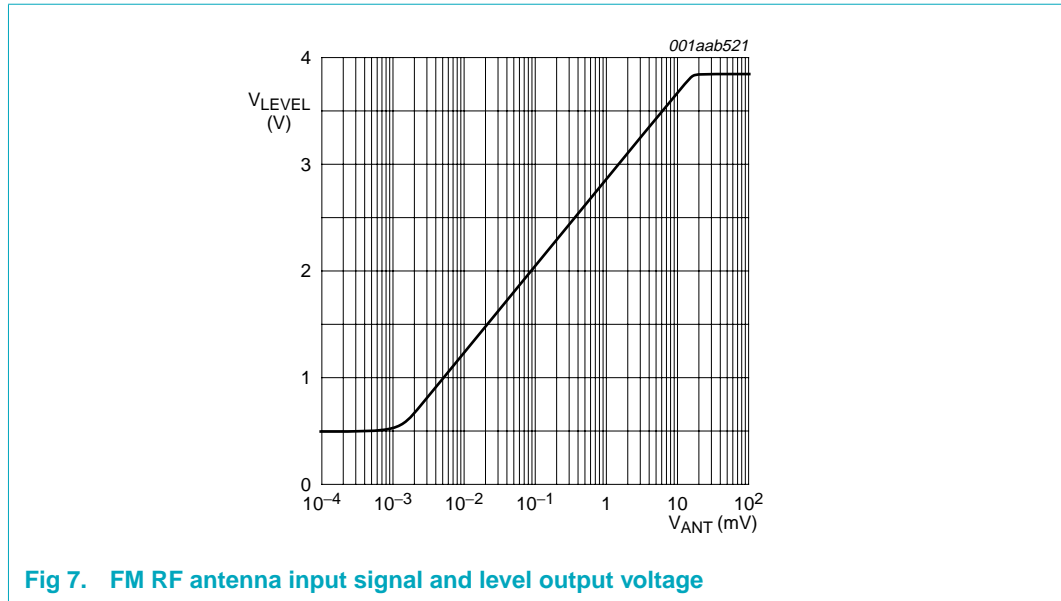

Fig 7. FM RF antenna input signal and level output voltage

8.1.3 Read mode: data byte USN/WAM

Table 11. USN/WAM - format of data byte 2

|      |      |      |      |      |      |      |      |
|------|------|------|------|------|------|------|------|
| 7    | 6    | 5    | 4    | 3    | 2    | 1    | 0    |
| USN3 | USN2 | USN1 | USN0 | WAM3 | WAM2 | WAM1 | WAM0 |

Table 12. USN/WAM - data byte 2 bit description

| Bit    | Symbol   | Description  |
|--------|----------|--|
| 7 to 4 | USN[3:0] | ultrasonic noise detector; this value indicates the USN content of the MPX audio signal; see <a href="#">Figure 24</a> |
| 3 to 0 | WAM[3:0] | wideband AM detector; this value indicates the WAM content of the LEVEL voltage; see <a href="#">Figure 24</a>         |

After AF update sampling the USN and WAM read value is held (indicated by IFCM = 10) for easy I<sup>2</sup>C-bus read-out. The USN and WAM detectors remain active in the background. The USN and WAM data hold is released after I<sup>2</sup>C-bus read.

## 8.1.4 Read mode: data byte MOD

Table 13. MOD - format of data byte 3

| 7    | 6    | 5    | 4    | 3    | 2    | 1    | 0    |
|------|------|------|------|------|------|------|------|
| MOD4 | MOD3 | MOD2 | MOD1 | MOD0 | STIN | TAS1 | TAS0 |

Table 14. MOD - data byte 3 bit description

| Bit     | Symbol   | Description   |
|---------|----------|---|
| 7 to 3  | MOD[4:0] | <p>modulation detector; this value indicates the audio modulation; see <a href="#">Table 15</a></p> <p>FM between 0 kHz and 150 kHz FM deviation</p> <p>AM between 0 % and 200 % modulation</p> <p>FM offset detector; a read value of 31 indicates offset detection. The offset detector is part of the FM bandwidth control algorithm and detects adjacent channel breakthrough.</p> <p>VU-meter; when an external audio source is selected and VU-meter read is active (see subaddress 17h; see <a href="#">Table 97</a>) MOD indicates the audio input level (RMS) between 0 V and 2 V; see <a href="#">Table 15</a>.</p> |
| 2       | STIN     | <p>stereo indicator; this bit indicates if a stereo pilot signal has been detected</p> <p>0 = no pilot signal detected</p> <p>1 = pilot signal is detected and the FM stereo decoder is activated</p>   |
| 1 and 0 | TAS[1:0] | <p>Tuning action state; state machine information. The signal TAS informs about internal control functions of the tuner action state machine. This way the progress of tuner actions can be monitored by the microcontroller.</p> <p>00 = inactive</p> <p>01 = starting mute</p> <p>10 = PLL tuning</p> <p>11 = tuning ready with mute active</p>   |

Table 15. MOD detector

| MOD4 | MOD3 | MOD2 | MOD1 | MOD0 | FM radio $\Delta f$ | AM radio m | VU     | External source |
|------|------|------|------|------|---------------------|------------|--------|-----------------|
| 0    | 0    | 0    | 0    | 0    | < 1.5 kHz           | < 2 %      | -      | < 0.02 V        |
| 0    | 0    | 0    | 0    | 1    | 1.5 kHz             | 2 %        | -34 dB | 0.02 V          |
| 0    | 0    | 0    | 1    | 0    | 3 kHz               | 4 %        | -28 dB | 0.04 V          |
| 0    | 0    | 0    | 1    | 1    | 4.5 kHz             | 6 %        | -24 dB | 0.06 V          |
| 0    | 0    | 1    | 0    | 0    | 6 kHz               | 8 %        | -22 dB | 0.08 V          |
| 0    | 0    | 1    | 0    | 1    | 7.5 kHz             | 10 %       | -20 dB | 0.1 V           |
| 0    | 0    | 1    | 1    | 0    | 9.5 kHz             | 13 %       | -18 dB | 0.13 V          |
| 0    | 0    | 1    | 1    | 1    | 12 kHz              | 16 %       | -16 dB | 0.16 V          |
| 0    | 1    | 0    | 0    | 0    | 15 kHz              | 20 %       | -14 dB | 0.2 V           |
| 0    | 1    | 0    | 0    | 1    | 19 kHz              | 25 %       | -12 dB | 0.25 V          |
| 0    | 1    | 0    | 1    | 0    | 24 kHz              | 32 %       | -10 dB | 0.32 V          |
| 0    | 1    | 0    | 1    | 1    | 30 kHz              | 40 %       | -8 dB  | 0.4 V           |
| 0    | 1    | 1    | 0    | 0    | 38 kHz              | 50 %       | -6 dB  | 0.5 V           |

Table 15. MOD detector ...continued

| MOD4 | MOD3 | MOD2 | MOD1 | MOD0 | FM radio $\Delta f$ | AM radio m | VU    | External source |
|------|------|------|------|------|---------------------|------------|-------|-----------------|
| 0    | 1    | 1    | 0    | 1    | 47 kHz              | 63 %       | -4 dB | 0.63 V          |
| 0    | 1    | 1    | 1    | 0    | 60 kHz              | 80 %       | -2 dB | 0.8 V           |
| 0    | 1    | 1    | 1    | 1    | 75 kHz              | 100 %      | 0 dB  | 1 V             |
| 1    | 0    | 0    | 0    | 0    | 95 kHz              | 125 %      | 2 dB  | 1.25 V          |
| 1    | 0    | 0    | 0    | 1    | 120 kHz             | 160 %      | 4 dB  | 1.6 V           |
| 1    | 0    | 0    | 1    | 0    | 150 kHz             | 200 %      | 6 dB  | 2 V             |
| 1    | 0    | 0    | 1    | 1    | -                   | -          | -     | -               |
| :    | :    | :    | :    | :    | :                   | :          | :     | :               |
| 1    | 1    | 1    | 1    | 0    | -                   | -          | -     | -               |
| 1    | 1    | 1    | 1    | 1    | OFFS<br>detection   | -          | -     | -               |

The indicated amplitude levels are approximate values.

In case of FM radio carrier modulation is measured (MPX FM deviation). Timing is fixed with fast 30 ms release time. Depending upon reception conditions and internal offsets small modulation levels may be indicated as 0. After AF update sampling the MOD read value is held (indicated by IFCM = 10) for easy I<sup>2</sup>C-bus read-out. The MOD detector remains active in the background. The MOD data hold is released after I<sup>2</sup>C-bus read.

In case of AM radio carrier modulation is measured (AM). Timing is fixed with fast 30 ms release time. Modulation may exceed 100 % in case of special modulation schemes as used by some stations. After AF update sampling the MOD read value is held (indicated by IFCM = 10) for easy I<sup>2</sup>C-bus read-out. The MOD detector remains active in the background. The MOD data hold is released after I<sup>2</sup>C-bus read.

With external source selection and VU-meter mode disabled (AVUM = 0 and COMP = 0) FM or AM modulation is indicated equal to radio mode.

With external source selection and VU-meter mode enabled (AVUM = 1 or COMP = 1) the audio input level of the external source is indicated (i.e. the audio level as found on the line input pins). For stereo signals left and right channel are combined for MOD read ( $0.5 \times L + 0.5 \times R$ ). VU-meter timing is defined by setting HCT. For AVUM control see subaddress 17h; see [Table 97](#). In case of AF update sampling the AM or FM modulation value is indicated with data hold (indicated by IFCM = 10) for easy I<sup>2</sup>C-bus read-out. The MOD data hold is released after I<sup>2</sup>C-bus read and VU-meter indication continues.

**8.1.5 Read mode: data byte IFBW**

**Table 16. IFBW - format of data byte 4**

| 7     | 6     | 5    | 4     | 3     | 2     | 1     | 0     |
|-------|-------|------|-------|-------|-------|-------|-------|
| RAGC1 | RAGC0 | ASIA | IFBW4 | IFBW3 | IFBW2 | IFBW1 | IFBW0 |

**Table 17. IFBW - data byte 4 bit description**

| Bit     | Symbol    | Description  |
|---------|-----------|--|
| 7 and 6 | RAGC[1:0] | RF AGC indicator; PIN diode current on pins IAMAGC or IFMAGC<br>00 =<br>FM: < 0.05 mA<br>AM: < 0.1 mA<br>01 =<br>FM: 0.05 mA to 0.5 mA<br>AM: 0.1 mA to 0.5 mA<br>10 = 0.5 mA to 2.5 mA<br>11 = > 2.5 mA |
| 5       | ASIA      | ASI active; this bit indicates activity of the audio step interpolation function<br>0 = ASI is not active<br>1 = ASI step is in progress   |
| 4 to 0  | IFBW[4:0] | FM IF filter bandwidth control; 57 kHz (0 0000) to 165 kHz (1 1111). The bandwidth read data equals the write data definition (at DYN = 0; see <a href="#">Table 28</a> ).                               |

**8.1.6 Read mode: data byte ID**

**Table 18. ID - format of data byte 5**

| 7      | 6 | 5 | 4 | 3 | 2   | 1   | 0   |
|--------|---|---|---|---|-----|-----|-----|
| IFCAPG | - | - | - | - | ID2 | ID1 | ID0 |

**Table 19. ID - data byte 5 bit description**

| Bit    | Symbol  | Description  |
|--------|---------|--|
| 7      | IFCAPG  | IF filter gear; read value is used for IFCAP adjustment (byte IFCAP); see <a href="#">Table 47</a> |
| 6 to 3 | -       | reserved   |
| 2 to 0 | ID[2:0] | device type identification 000 = TEF6901A  |

### 8.1.7 Read mode: data byte TEMP

Table 20. TEMP - format of data byte 6

| 7     | 6     | 5     | 4     | 3     | 2     | 1     | 0     |
|-------|-------|-------|-------|-------|-------|-------|-------|
| TEMP7 | TEMP6 | TEMP5 | TEMP4 | TEMP3 | TEMP2 | TEMP1 | TEMP0 |

Table 21. TEMP - data byte 6 bit description

| Bit    | Symbol    | Description  |
|--------|-----------|--|
| 7 to 0 | TEMP[7:0] | on-chip temperature; 1 step $\approx$ 1 K; relative indication |

## 8.2 Write mode

The device is controlled by the I<sup>2</sup>C-bus. After the Integrated Circuit (IC) address the MSA byte contains the control of the tuning action via the bits MODE[2:0] and subaddressing via bits SA[4:0] (see [Figure 8](#)).

All circuits are controlled by the CONTROL register. Any data change in the CONTROL register has immediate effect and will change the operation of the circuit accordingly. The subaddress range 00h to 05h includes data that may lead to audible disturbance when changed. Therefore the subaddress range 00h to 05h is not loaded in the CONTROL register directly but loaded in a BUFFER register instead. This allows the IC to take care of tuning actions and mute control, freeing the microcontroller from cumbersome controls and timings. The subaddress range of 06h onwards does not contain such critical data. I<sup>2</sup>C-bus information in this range will be loaded in the CONTROL register directly (at acknowledge of each byte).

Controlled by a state machine the BUFFER data will be loaded in the CONTROL register for new settings. However at the same time the CONTROL data is loaded in the BUFFER register. This register swap action allows a fast return to the previous setting because the previous data remains available in the BUFFER register (see [Figure 9](#)).

Via MODE several operational modes can be selected for the state machine. MODE offers all standard tuning actions as well as generic control for flexibility. The state machine controls the tuner directly by controlling the I<sup>2</sup>C-bus data. Internal circuits like the IF counter, mute and weak signal processing are controlled complementary to the tuner action. The state machine operation starts at the end of transmission (P = STOP). In case a previous action is still active this is overruled and the new action defined by MODE is started immediately.

When only the address byte is transmitted no action is started and no setting is changed, this can be used to test the presence of the device on the bus. To minimize the I<sup>2</sup>C-bus transmission time only bytes that include data changes need to be written. Following the MSA byte the transmission can start at any given data byte defined by the subaddress (SA) bits. In case of MODE = preset, search or load the value of buffered data that is not overwritten by the new transmission will equal the control register content, i.e. the current tuner state. Instead in case of MODE = buffer, AF update, jump, check or end any not overwritten BUFFER data remains to be the existing BUFFER register content, i.e. the previous tuner state.

After power-on reset all registers, including the reserved registers, should be initialized with their default settings (see [Table 22](#)) using a preset mode tuning action (see [Table 25](#)). The tuning mute circuit is muted. An action of the state machine is required to de-mute the circuit, for this purpose preset mode (bits MODE[2:0] = 001) is best fitted since it assures fast settling of all parameters before mute is released.

**Table 22. Write mode subaddress overview**

| Subaddress | Name      | Default   | Reference                      |
|------------|-----------|-----------|--------------------------------|
| 00h        | BANDWIDTH | 1111 1110 | <a href="#">Section 8.2.2</a>  |
| 01h        | PLLM      | 0000 1000 | <a href="#">Section 8.2.3</a>  |
| 02h        | PLLL      | 0111 1110 | <a href="#">Section 8.2.3</a>  |
| 03h        | DAA       | 0100 0000 | <a href="#">Section 8.2.4</a>  |
| 04h        | AGC       | 0000 0000 | <a href="#">Section 8.2.5</a>  |
| 05h        | BAND      | 0010 0000 | <a href="#">Section 8.2.6</a>  |
| 06h        | LEVELALGN | 1000 0100 | <a href="#">Section 8.2.8</a>  |
| 07h        | IFCF      | 0010 0000 | <a href="#">Section 8.2.9</a>  |
| 08h        | IFCAP     | 0000 1000 | <a href="#">Section 8.2.10</a> |
| 09h        | ACD       | 0100 1010 | <a href="#">Section 8.2.11</a> |
| 0Ah        | SENSE     | 1000 0101 | <a href="#">Section 8.2.12</a> |
| 0Bh        | TIMING    | 0110 0110 | <a href="#">Section 8.2.13</a> |
| 0Ch        | SNC       | 0111 0100 | <a href="#">Section 8.2.14</a> |
| 0Dh        | HIGHCUT   | 0110 1111 | <a href="#">Section 8.2.15</a> |
| 0Eh        | SOFTMUTE  | 0110 1010 | <a href="#">Section 8.2.16</a> |
| 0Fh        | RADIO     | 0001 1010 | <a href="#">Section 8.2.17</a> |
| 10h        | INPUT     | 0000 1010 | <a href="#">Section 8.2.18</a> |
| 11h        | VOLUME    | 0011 0000 | <a href="#">Section 8.2.19</a> |
| 12h        | TREBLE    | 0000 1100 | <a href="#">Section 8.2.20</a> |
| 13h        | BASS      | 0000 1100 | <a href="#">Section 8.2.21</a> |
| 14h        | FADER     | 0000 0000 | <a href="#">Section 8.2.22</a> |
| 15h        | OUTPUT    | 0000 1111 | <a href="#">Section 8.2.23</a> |
| 16h        | BALANCE   | 1000 0000 | <a href="#">Section 8.2.24</a> |
| 17h        | LOUDNESS  | 0000 1100 | <a href="#">Section 8.2.25</a> |
| 18h        | POWER     | 0000 0110 | <a href="#">Section 8.2.26</a> |
| 19h to 1Eh | reserved  | 0000 0000 | <a href="#">Section 8.2.27</a> |
| 1Fh        | TEST      | 0000 0000 | <a href="#">Section 8.2.28</a> |

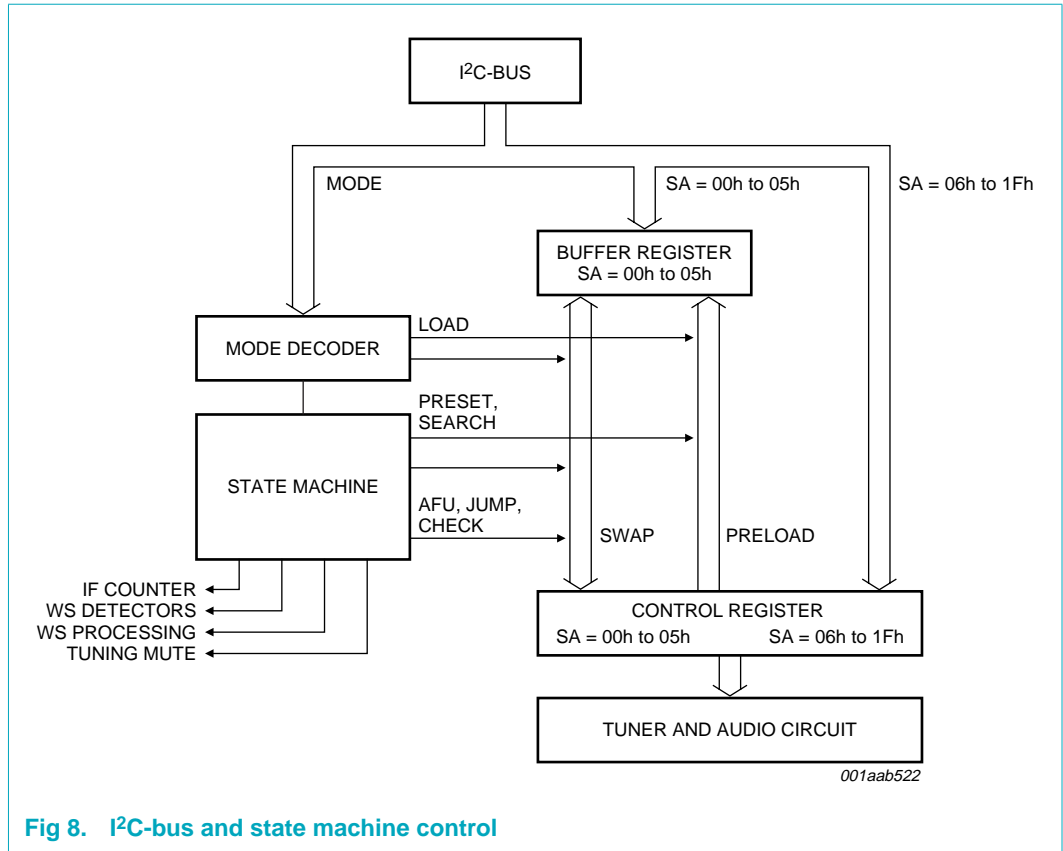
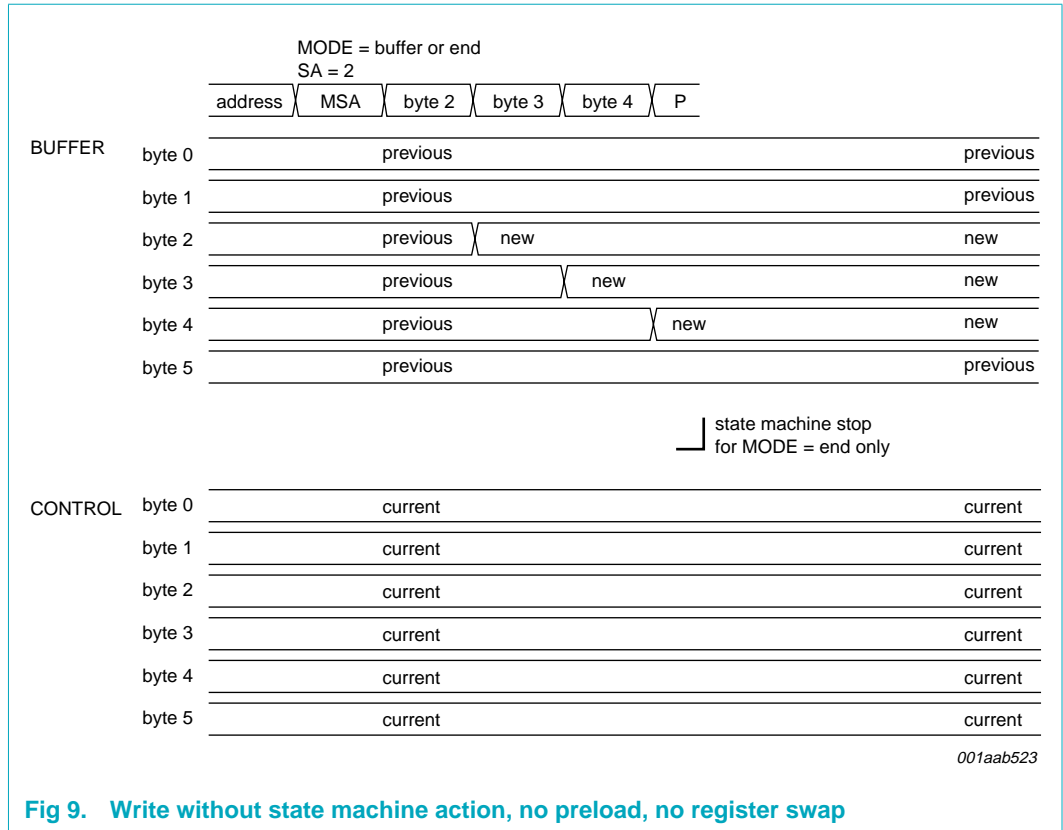
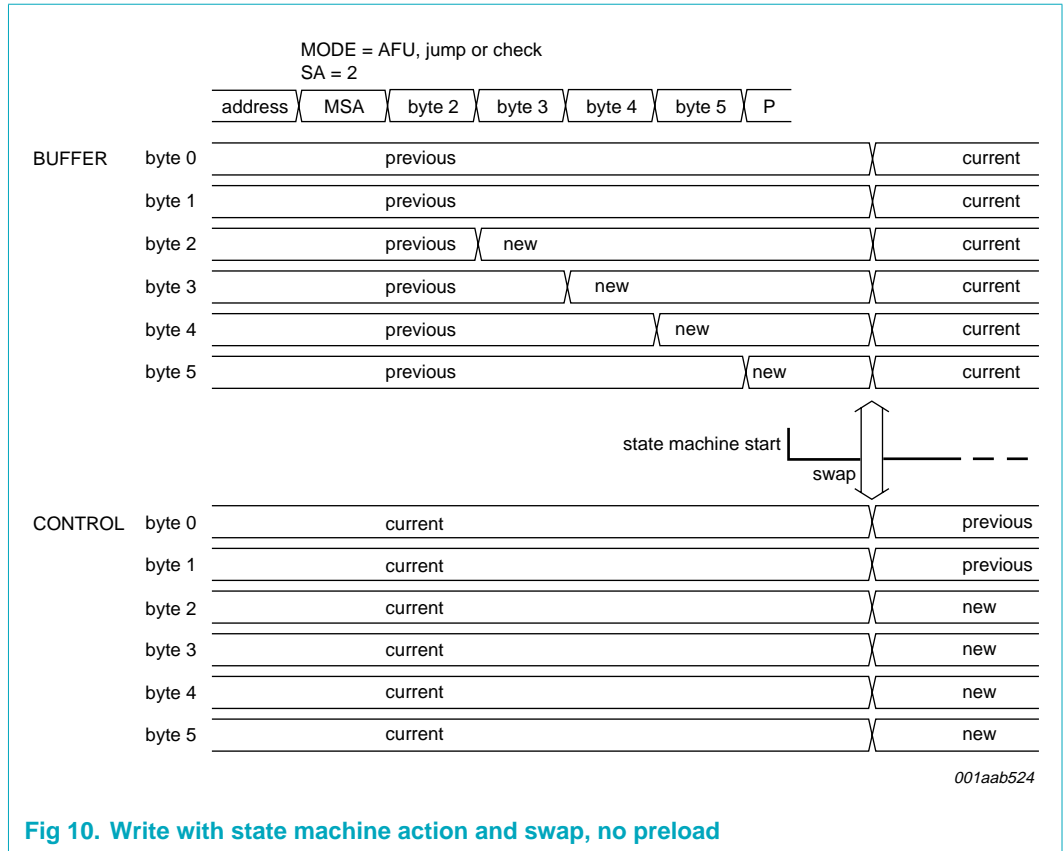

Fig 8. I<sup>2</sup>C-bus and state machine control



**Fig 9. Write without state machine action, no preload, no register swap**





**Fig 10. Write with state machine action and swap, no preload**

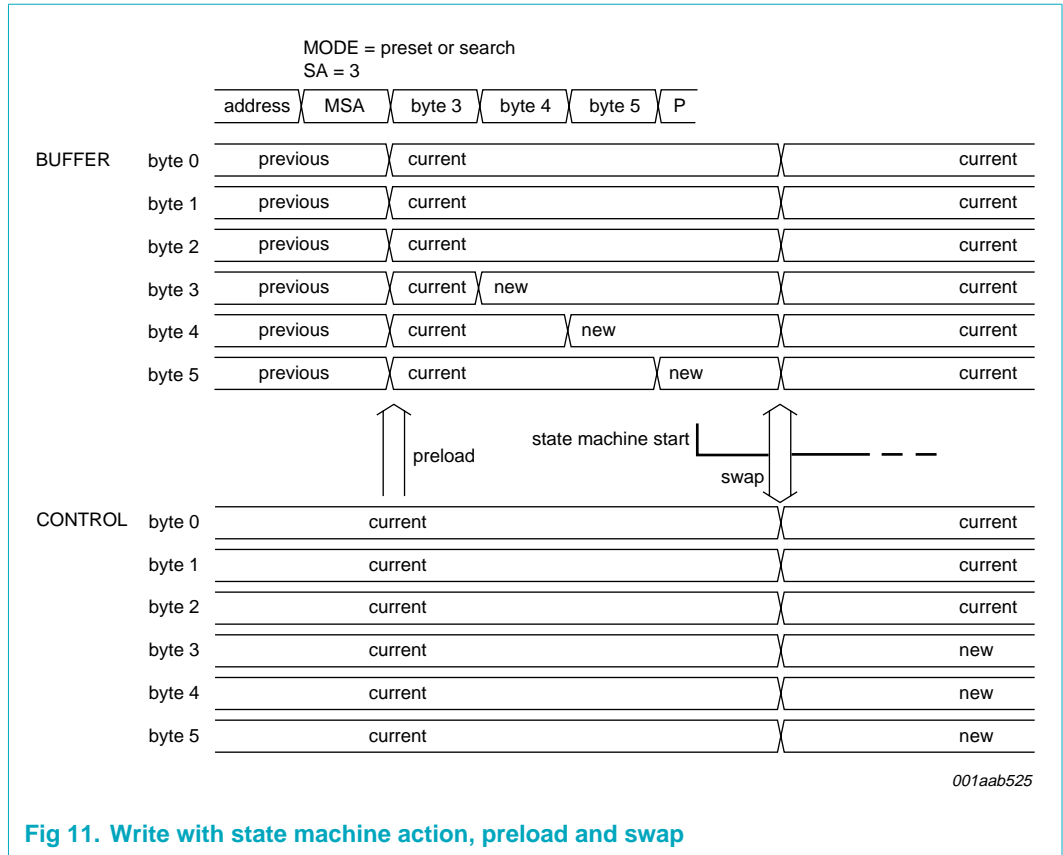

Fig 11. Write with state machine action, preload and swap

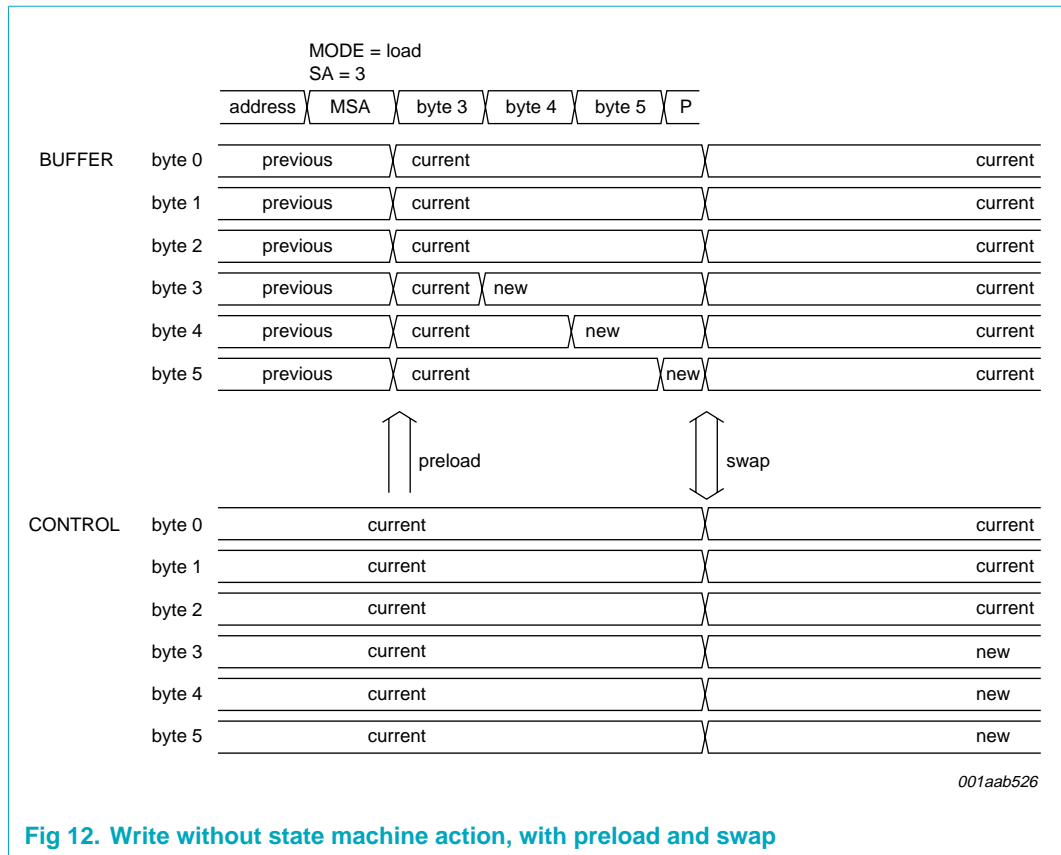

Fig 12. Write without state machine action, with preload and swap

### 8.2.1 Mode and subaddress byte for write

Table 23. MSA - format of mode and subaddress byte

| 7     | 6     | 5     | 4   | 3   | 2   | 1   | 0   |
|-------|-------|-------|-----|-----|-----|-----|-----|
| MODE2 | MODE1 | MODE0 | SA4 | SA3 | SA2 | SA1 | SA0 |

Table 24. MSA - mode and subaddress byte bit description

| Bit    | Symbol    | Description   |
|--------|-----------|---|
| 7 to 5 | MODE[2:0] | mode tuning action; see <a href="#">Table 25</a>  |
| 4 to 0 | SA[4:0]   | Subaddress; 0 0000 to 1 1111 = write data byte subaddress 00h to 1Fh. The subaddress value is auto-incremented and will revert from SA = 1Fh to SA = 00h. The auto-increment function cannot be disabled. |

Table 25. Tuning action modes

| MODE2 | MODE1 | MODE0 | Symbol    | Description   |
|-------|-------|-------|-----------|---|
| 0     | 0     | 0     | buffer    | write BUFFER register, no state machine action, no register swap; see <a href="#">Figure 9</a>  |
| 0     | 0     | 1     | preset    | tune to new program with 60 ms mute control; swap; see <a href="#">Figure 13</a> and <a href="#">Figure 14</a> ; BUFFER is preloaded with CONTROL register; immediate swap; see <a href="#">Figure 11</a> |
| 0     | 1     | 0     | search    | tune to new program and stay muted (to release use end); swap; see <a href="#">Figure 15</a> and <a href="#">Figure 16</a> ; BUFFER is preloaded with CONTROL register; see <a href="#">Figure 11</a>     |
| 0     | 1     | 1     | AF update | tune to AF program; check AF quality and tune back to main program; two register swap operations; see <a href="#">Figure 17</a> and <a href="#">Figure 18</a>   |
| 1     | 0     | 0     | jump      | tune to AF program in minimum time; register swap; see <a href="#">Figure 19</a> and <a href="#">Figure 20</a>  |
| 1     | 0     | 1     | check     | tune to AF program and stay muted (to release use end); register swap; see <a href="#">Figure 21</a> and <a href="#">Figure 22</a>  |
| 1     | 1     | 0     | load      | write CONTROL register via BUFFER; no state machine action; BUFFER is preloaded with CONTROL register; immediate swap; see <a href="#">Figure 12</a>  |
| 1     | 1     | 1     | end       | end action; release mute; no register swap; see <a href="#">Figure 9</a> and <a href="#">Figure 23</a>  |

Since buffer mode (bits MODE[2:0] = 000) does not change any tuner action or register other than those defined by the I<sup>2</sup>C-bus write transmission it generally is the mode used for writing outside the buffered subaddress range (i.e. bits SA[4:0] = 06h to 1Fh). Writing in the subaddress range of 06h to 1Fh is executed immediately and is not controlled by the state machine. Load mode does not interrupt a state machine process, the preload action changes the content of the BUFFER register which may interfere with a tuner action in progress.

When a new state machine tuning action is started during a mute state of the state machine, the new action skips the unnecessary activation of mute and starts immediately with the actions that follow the mute period in the standard sequence. In this way fastest timing is possible e.g. for search tuning (see [Figure 14](#), [Figure 16](#), [Figure 20](#) and [Figure 22](#)). When AF update mode is started during a mute state only the return tuning action will be performed; in combination with check mode an AF update can be created with the AF sampling time defined by I<sup>2</sup>C-bus control (see [Figure 18](#)).

The FM IF2 signal path contains a digital controlled AGC function with a maximum AGC decay time of 13 ms to realize sufficient AM suppression during changing signal conditions and high modulation situations. During the settling of the AGC (e.g. after a tuning action), the gain of the FM path and the level detection can be affected. To get correct signal quality information, a minimum time of 13 ms should be used between two tuning actions.

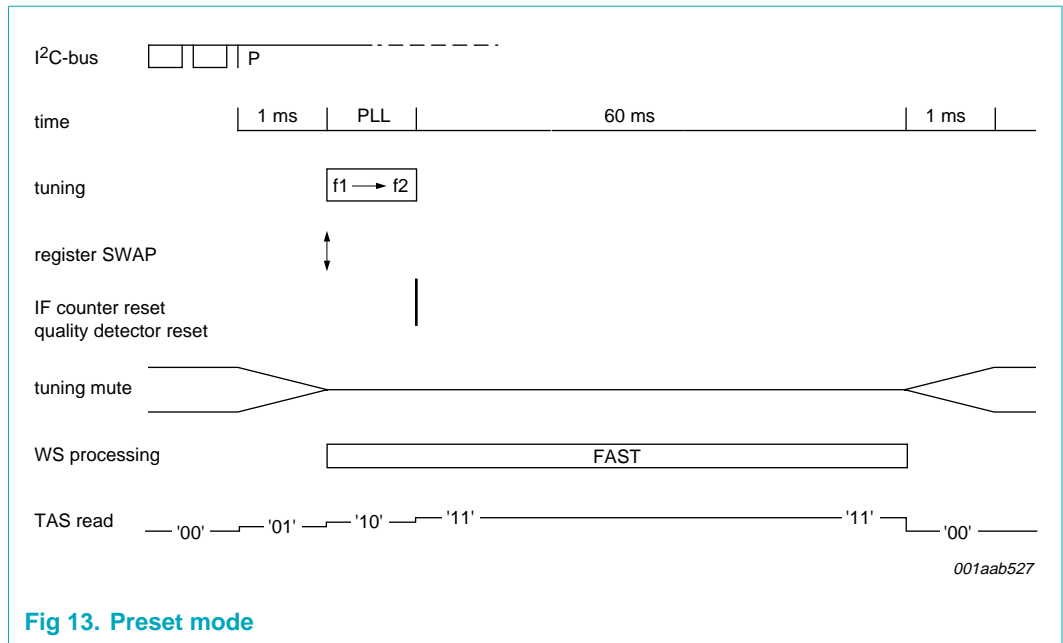

Fig 13. Preset mode

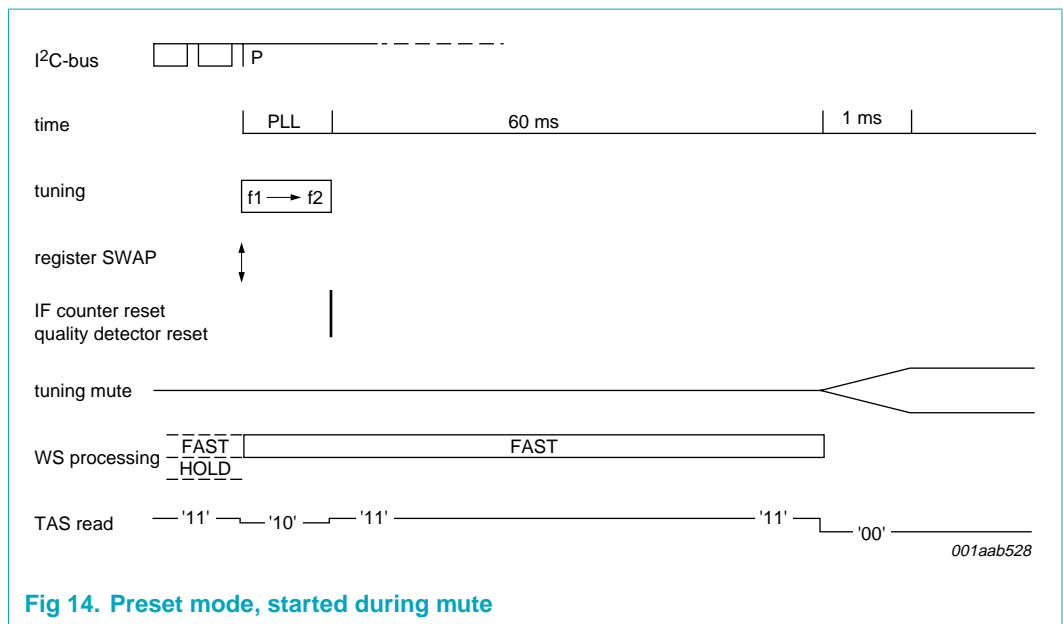

Fig 14. Preset mode, started during mute

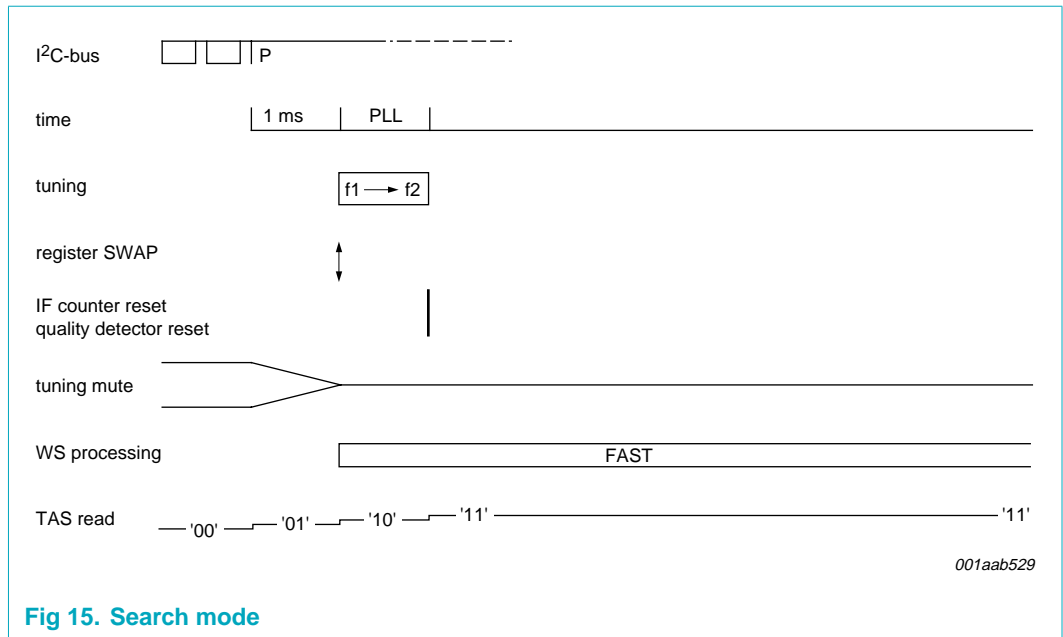

Fig 15. Search mode

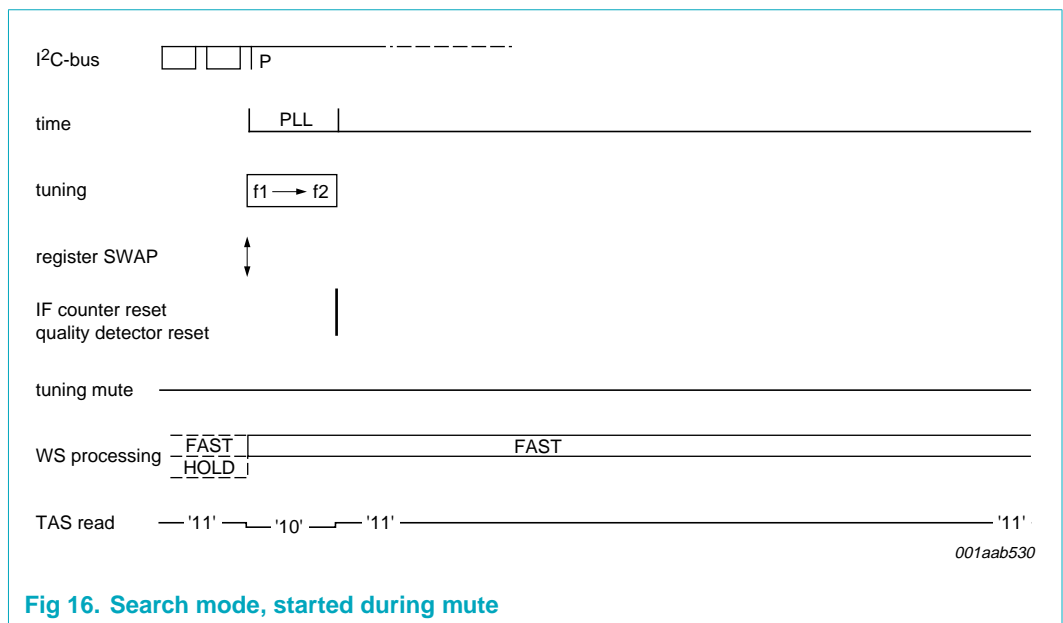

Fig 16. Search mode, started during mute

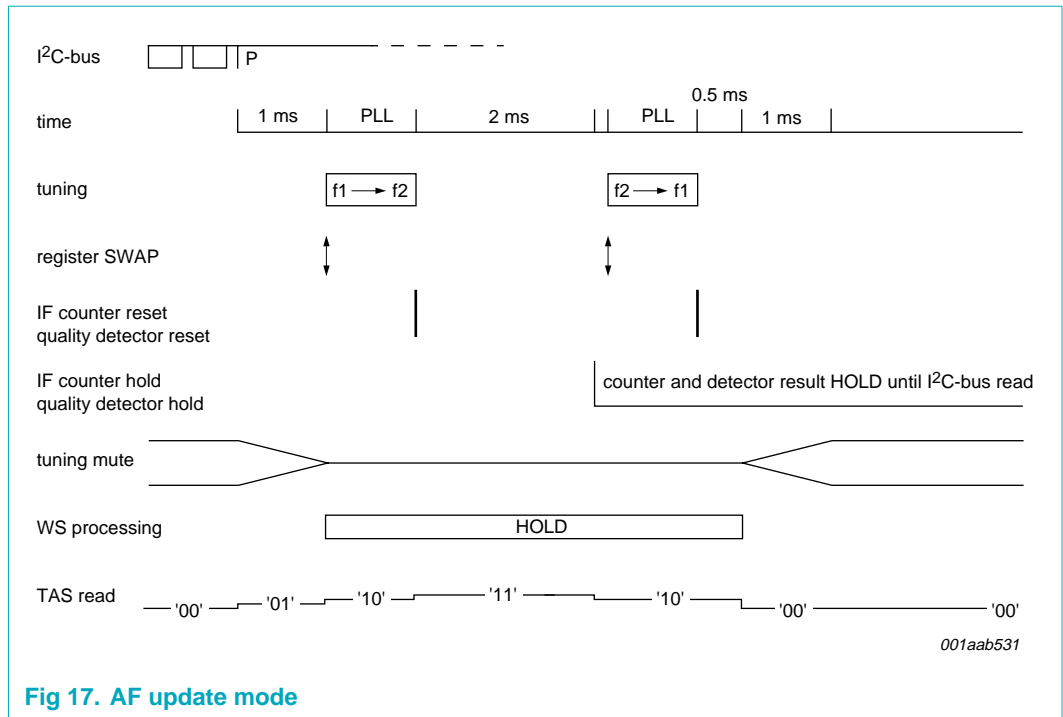

Fig 17. AF update mode

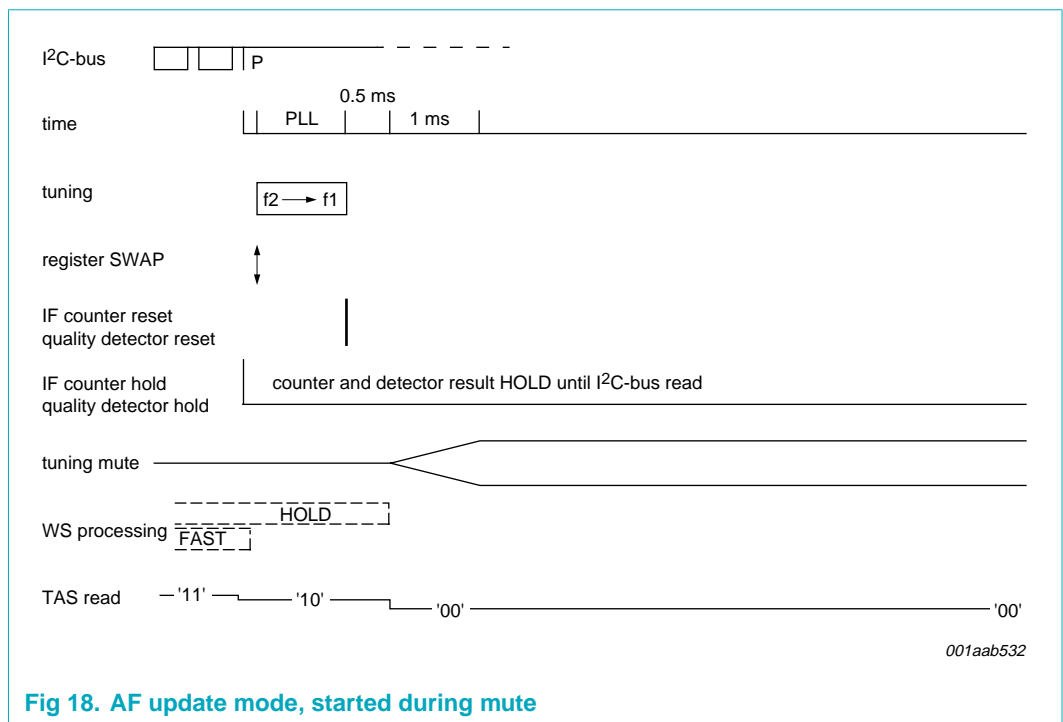

Fig 18. AF update mode, started during mute

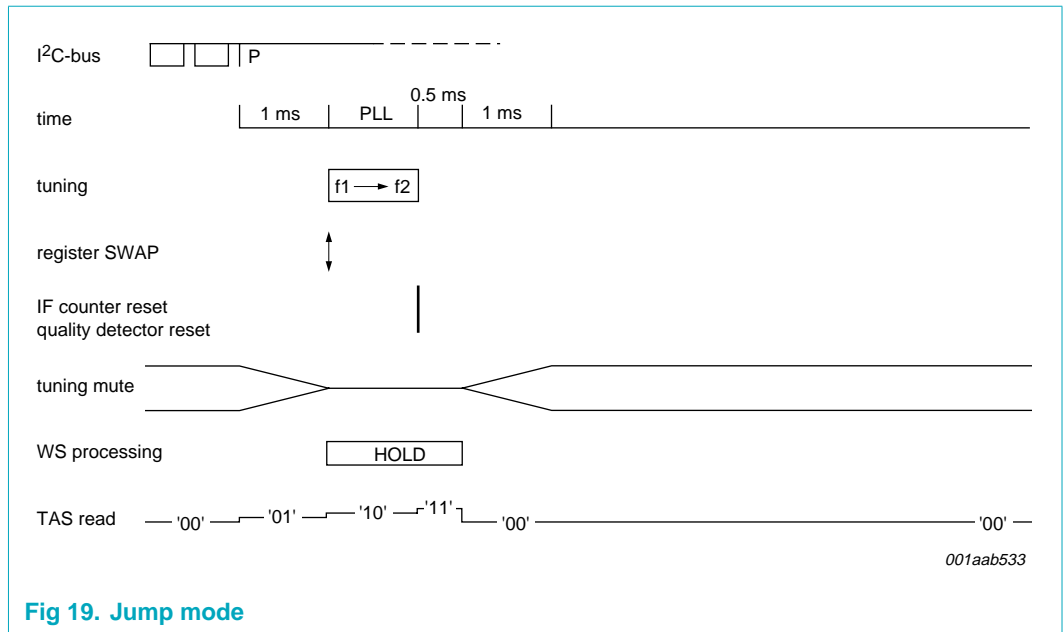

Fig 19. Jump mode

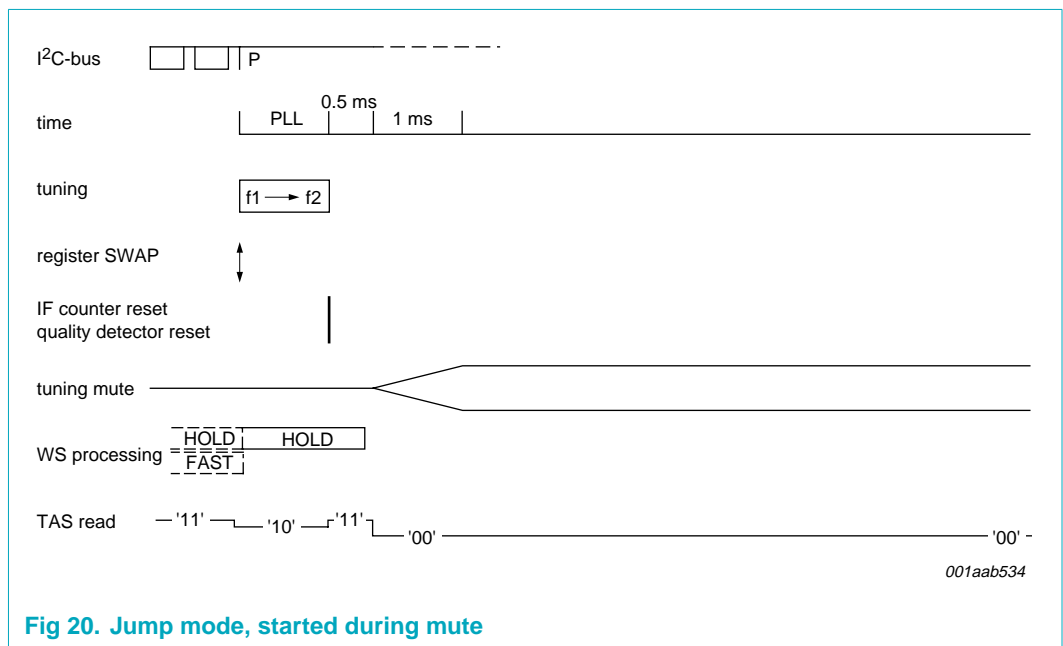
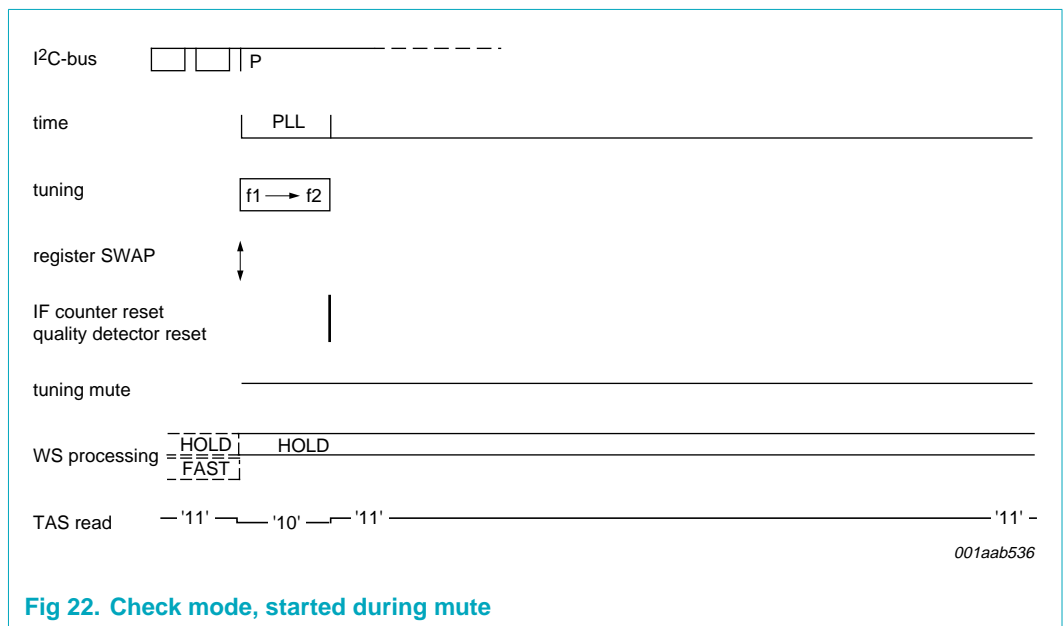
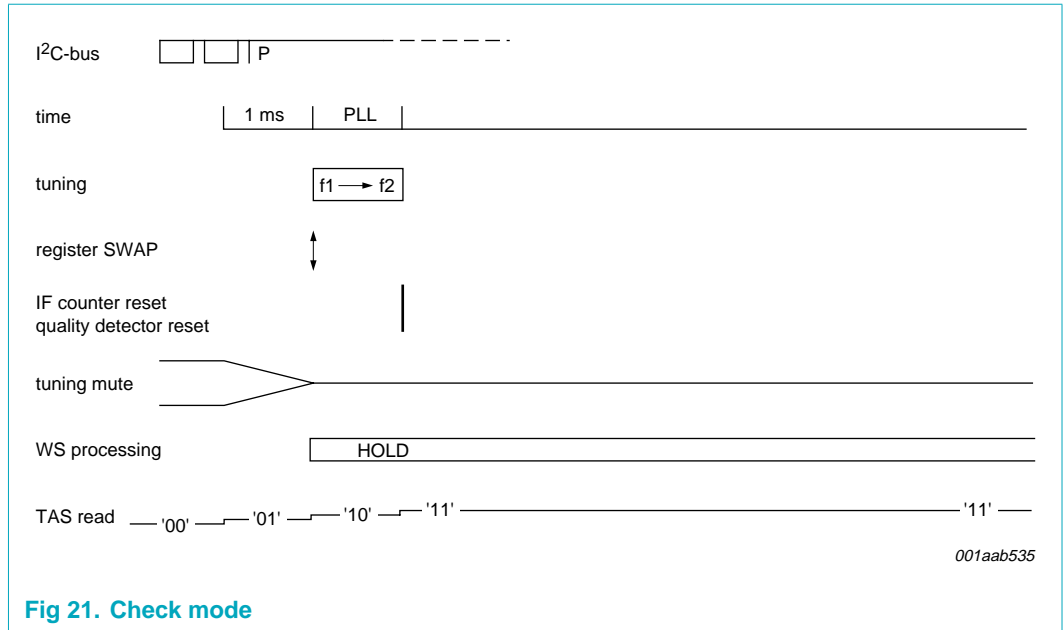

Fig 20. Jump mode, started during mute





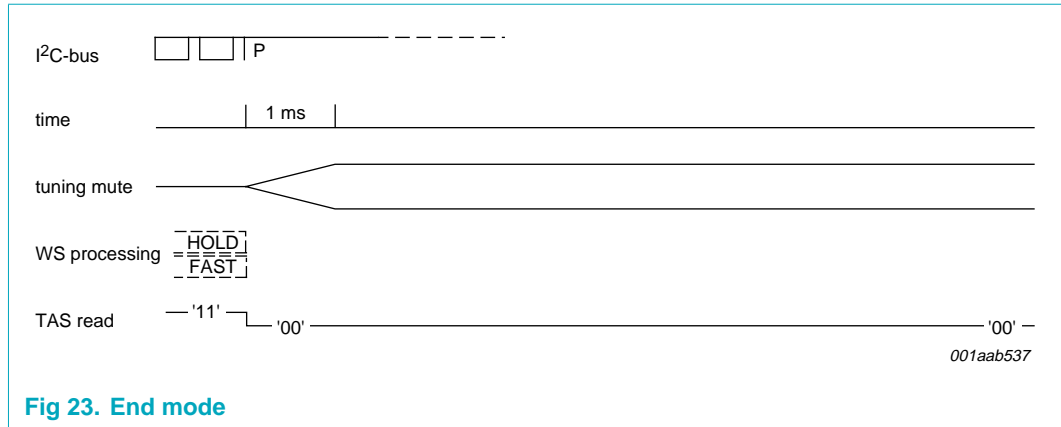

Fig 23. End mode

### 8.2.2 Write mode: data byte BANDWIDTH

Table 26. BANDWIDTH - format of data byte 00h with default setting (buffered)

| 7   | 6   | 5   | 4   | 3   | 2   | 1   | 0   |
|-----|-----|-----|-----|-----|-----|-----|-----|
| DYN | BW4 | BW3 | BW2 | BW1 | BW0 | TE1 | TE0 |
| 1   | 1   | 1   | 1   | 1   | 1   | 1   | 0   |

Table 27. BANDWIDTH - data byte 00h bit description

| Bit     | Symbol  | Description  |
|---------|---------|--|
| 7       | DYN     | dynamic bandwidth; see <a href="#">Table 28</a><br>0 = FM IF bandwidth set by BW<br>1 = FM IF bandwidth dynamically controlled   |
| 6 to 2  | BW[4:0] | FM IF bandwidth; see <a href="#">Table 28</a><br>DYN = 0<br>00h to 1Fh = FM fixed IF bandwidth 57 kHz to 165 kHz<br>DYN = 1<br>00h to 0Fh = minimum dynamic bandwidth 57 kHz to 109 kHz<br>10h to 1Fh = maximum dynamic bandwidth 113 kHz to 165 kHz |
| 1 and 0 | TE[1:0] | threshold extension<br>00 = no threshold extension<br>01 = threshold extension low<br>10 = threshold extension standard<br>11 = threshold extension high   |

Table 28. FM IF bandwidth selection

| BW4 | BW3 | BW2 | BW1 | BW0 | DYN = 0 | DYN = 1            |
|-----|-----|-----|-----|-----|---------|--------------------|
| 0   | 0   | 0   | 0   | 0   | 57 kHz  | 57 kHz to 165 kHz  |
| 0   | 0   | 0   | 0   | 1   | 60 kHz  | 60 kHz to 165 kHz  |
| 0   | 0   | 0   | 1   | 0   | 64 kHz  | 64 kHz to 165 kHz  |
| 0   | 0   | 0   | 1   | 1   | 67 kHz  | 67 kHz to 165 kHz  |
| 0   | 0   | 1   | 0   | 0   | 71 kHz  | 71 kHz to 165 kHz  |
| 0   | 0   | 1   | 0   | 1   | 74 kHz  | 74 kHz to 165 kHz  |
| 0   | 0   | 1   | 1   | 0   | 78 kHz  | 78 kHz to 165 kHz  |
| 0   | 0   | 1   | 1   | 1   | 81 kHz  | 81 kHz to 165 kHz  |
| 0   | 1   | 0   | 0   | 0   | 85 kHz  | 85 kHz to 165 kHz  |
| 0   | 1   | 0   | 0   | 1   | 88 kHz  | 88 kHz to 165 kHz  |
| 0   | 1   | 0   | 1   | 0   | 92 kHz  | 92 kHz to 165 kHz  |
| 0   | 1   | 0   | 1   | 1   | 95 kHz  | 95 kHz to 165 kHz  |
| 0   | 1   | 1   | 0   | 0   | 99 kHz  | 99 kHz to 165 kHz  |
| 0   | 1   | 1   | 0   | 1   | 102 kHz | 102 kHz to 165 kHz |
| 0   | 1   | 1   | 1   | 0   | 106 kHz | 106 kHz to 165 kHz |
| 0   | 1   | 1   | 1   | 1   | 109 kHz | 109 kHz to 165 kHz |
| 1   | 0   | 0   | 0   | 0   | 113 kHz | 57 kHz to 113 kHz  |
| 1   | 0   | 0   | 0   | 1   | 116 kHz | 57 kHz to 116 kHz  |
| 1   | 0   | 0   | 1   | 0   | 120 kHz | 57 kHz to 120 kHz  |
| 1   | 0   | 0   | 1   | 1   | 123 kHz | 57 kHz to 123 kHz  |
| 1   | 0   | 1   | 0   | 0   | 127 kHz | 57 kHz to 127 kHz  |
| 1   | 0   | 1   | 0   | 1   | 130 kHz | 57 kHz to 130 kHz  |
| 1   | 0   | 1   | 1   | 0   | 134 kHz | 57 kHz to 134 kHz  |
| 1   | 0   | 1   | 1   | 1   | 137 kHz | 57 kHz to 137 kHz  |
| 1   | 1   | 0   | 0   | 0   | 141 kHz | 57 kHz to 141 kHz  |
| 1   | 1   | 0   | 0   | 1   | 144 kHz | 57 kHz to 144 kHz  |
| 1   | 1   | 0   | 1   | 0   | 148 kHz | 57 kHz to 148 kHz  |
| 1   | 1   | 0   | 1   | 1   | 151 kHz | 57 kHz to 151 kHz  |
| 1   | 1   | 1   | 0   | 0   | 155 kHz | 57 kHz to 155 kHz  |
| 1   | 1   | 1   | 0   | 1   | 158 kHz | 57 kHz to 158 kHz  |
| 1   | 1   | 1   | 1   | 0   | 162 kHz | 57 kHz to 162 kHz  |
| 1   | 1   | 1   | 1   | 1   | 165 kHz | 57 kHz to 165 kHz  |

### 8.2.3 Write mode: data bytes PLLM and PLLL

Table 29. PLLM - format of data byte 01h with default setting (buffered)

| 7      | 6     | 5     | 4     | 3     | 2     | 1    | 0    |
|--------|-------|-------|-------|-------|-------|------|------|
| RFGAIN | PLL14 | PLL13 | PLL12 | PLL11 | PLL10 | PLL9 | PLL8 |
| 0      | 0     | 0     | 0     | 1     | 0     | 0    | 0    |

Table 30. PLLL - format of data byte 02h with default setting (buffered)

| 7    | 6    | 5    | 4    | 3    | 2    | 1    | 0    |
|------|------|------|------|------|------|------|------|
| PLL7 | PLL6 | PLL5 | PLL4 | PLL3 | PLL2 | PLL1 | PLL0 |
| 0    | 1    | 1    | 1    | 1    | 1    | 1    | 0    |

Table 31. PLLM and PLLL - data byte 01h and data byte 02h bit description

| Bit                              | Symbol    | Description   |
|----------------------------------|-----------|---|
| 7 (PLL M)                        | RFGAIN    | RF gain setting in FM mode<br>0 = standard RF gain<br>1 = +6 dB additional RF gain at FM mixer 1      |
| 6 to 0 (PLL M)<br>7 to 0 (PLL L) | PLL[14:0] | VCO programmable divider N; application range of N = 1024 to 32767; see <a href="#">Section 8.2.7</a> |

### 8.2.4 Write mode: data byte DAA

Table 32. DAA - format of data byte 03h with default setting (buffered)

| 7 | 6    | 5    | 4    | 3    | 2    | 1    | 0    |
|---|------|------|------|------|------|------|------|
| 0 | DAA6 | DAA5 | DAA4 | DAA3 | DAA2 | DAA1 | DAA0 |
|   | 1    | 0    | 0    | 0    | 0    | 0    | 0    |

Table 33. DAA - data byte 03h bit description

| Bit    | Symbol   | Description  |
|--------|----------|--|
| 7      | -        | reserved; 0 = normal operation   |
| 6 to 0 | DAA[6:0] | RF selectivity alignment<br>FM: alignment of antenna circuit tuning voltage ( $0.1 \times V_{VCO}$ to $2.0 \times V_{VCO}$ )<br>AM: voltage Digital-to-Analog Converter (DAC) output ( $0.1 \times 4.3$ V to $2.0 \times 4.3$ V) |

### 8.2.5 Write mode: data byte AGC

Table 34. AGC - format of data byte 04h with default setting (buffered)

| 7     | 6      | 5 | 4 | 3    | 2    | 1    | 0    |
|-------|--------|---|---|------|------|------|------|
| AGCSW | IFGAIN | 0 | 0 | AGC1 | AGC0 | KAGC | LODX |
| 0     | 0      |   |   | 0    | 0    | 0    | 0    |

Table 35. AGC - data byte 04h bit description

| Bit     | Symbol   | Description  |
|---------|----------|--|
| 7       | AGCSW    | RF AGC switch<br>0 = no control of unused RF AGC<br>1 = unused AM RF AGC PIN diode at FM mode, or unused FM RF AGC PIN diode at AM mode is supplied with a constant current for fixed attenuation  |
| 6       | IFGAIN   | IF gain<br>0 = IF gain for low loss 10.7 MHz filter<br>1 = increased IF gain (3 dB) for high loss 10.7 MHz filter  |
| 5 and 4 | -        | reserved; 0 = normal operation   |
| 3 and 2 | AGC[1:0] | setting of RF AGC threshold voltage<br>FM mixer 1 input voltage (RMS value)<br>00 = 24 mV<br>01 = 17 mV<br>10 = 12 mV<br>11 = 9 mV<br>AM mixer 1 input voltage (peak-to-peak value)<br>00 = 1000 mV<br>01 = 700 mV<br>10 = 500 mV<br>11 = 350 mV   |
| 1       | KAGC     | keyed AGC<br>FM mode<br>0 = keyed AGC off<br>1 = keyed AGC on; the AGC start level is shifted to a value 10 dB above the standard AGC start level, when the level voltage of the wanted RF signal is below the threshold level voltage for narrow-band AGC<br>AM mode<br>0 = RF cascode AGC enabled with full range<br>1 = RF cascode AGC enabled with limited range |
| 0       | LODX     | FM: local switch<br>0 = standard operation (DX)<br>1 = forced FM RF AGC attenuation (LOCAL)<br>AM: trigger signal from AM IF noise blanker to AM audio noise blanker<br>0 = trigger signal active for low modulation ( $m < 0.05$ ) only<br>1 = trigger signal always active, independent of modulation  |

## 8.2.6 Write mode: data byte BAND

**Table 36. BAND - format of data byte 05h with default setting (buffered)**

| 7     | 6     | 5     | 4     | 3     | 2     | 1     | 0 |
|-------|-------|-------|-------|-------|-------|-------|---|
| BAND2 | BAND1 | BAND0 | FREF2 | FREF1 | FREF0 | LOINJ | 0 |
| 0     | 0     | 1     | 0     | 0     | 0     | 0     |   |

**Table 37. BAND - data byte 05h bit description**

| Bit    | Symbol    | Description   |
|--------|-----------|---|
| 7 to 5 | BAND[2:0] | FM and AM band selection; see <a href="#">Table 38</a>  |
| 4 to 2 | FREF[2:0] | PLL reference frequency; see <a href="#">Table 39</a>   |
| 1      | LOINJ     | FM mixer 1 image suppression<br>0 = high injection image suppression<br>1 = low injection image suppression |
| 0      | -         | reserved; 0 = normal operation  |

**Table 38. Decoding of BAND bits**

| BAND2 | BAND1 | BAND0 | Divider ratio M | Receiver band |
|-------|-------|-------|-----------------|---------------|
| 0     | 0     | 0     | -               | reserved      |
| 0     | 0     | 1     | 2               | FM            |
| 0     | 1     | 0     | 3               | FM            |
| 0     | 1     | 1     | 6               | AM            |
| 1     | 0     | 0     | 8               | AM            |
| 1     | 0     | 1     | 10              | AM            |
| 1     | 1     | 0     | 16              | AM            |
| 1     | 1     | 1     | 20              | AM            |

**Table 39. Reference frequencies**

| FREF2 | FREF1 | FREF0 | f <sub>ref</sub> |
|-------|-------|-------|------------------|
| 0     | 0     | 0     | 100 kHz          |
| 0     | 0     | 1     | 50 kHz           |
| 0     | 1     | 0     | 25 kHz           |
| 0     | 1     | 1     | 20 kHz           |
| 1     | 0     | 0     | 10 kHz           |
| 1     | 0     | 1     | reserved         |
| 1     | 1     | 0     | reserved         |
| 1     | 1     | 1     | reserved         |

Different PLL charge pump currents are used for different reference frequencies to maintain best PLL loop stability; see [Table 40](#).

Settings FREF[2:0] = 000 (100 kHz) and FREF[2:0] = 001 (50 kHz) include additional high current charge pump control to realize fast PLL locking within 1 ms.

Table 40. Charge pump source<sup>[1]</sup>

| FREF2 | FREF1 | FREF0 | LOINJ | Charge pump current | f <sub>ref</sub> |
|-------|-------|-------|-------|---------------------|------------------|
| 0     | 0     | 0     | X     | CP1                 | 100 kHz          |
| 0     | 0     | 1     | X     | CP2                 | 50 kHz           |
| 0     | 1     | 0     | X     | CP3                 | 25 kHz           |
| 0     | 1     | 1     | 1     | CP3                 | 20 kHz           |
| 0     | 1     | 1     | 0     | CP4                 | 20 kHz           |
| 1     | 0     | 0     | X     | CP5                 | 10 kHz           |
| 1     | 0     | 1     | X     | reserved            |                  |
| 1     | 1     | 0     | X     | reserved            |                  |
| 1     | 1     | 1     | X     | reserved            |                  |

[1] X = don't care.

### 8.2.7 Tuning overview

High injection LO (Europe FM, US FM and AM):

$$N = \frac{(f_{RF} + 10.7 \text{ MHz}) \times M}{f_{ref}} \text{ with LOINJ} = 0 \text{ to achieve full image suppression in FM.}$$

Low injection LO (Japan FM and OIRT):

$$N = \frac{(f_{RF} - 10.7 \text{ MHz}) \times M}{f_{ref}} \text{ with LOINJ} = 1 \text{ to achieve full image suppression in FM.}$$

$$\text{tuning step} = \frac{f_{ref}}{M}$$

where: M is the divider ratio of the VCO frequency for AM mixer 1 and FM mixer 1

$$M = \frac{f_{VCO}}{f_{mixer 1}}$$

Table 41. Standard tuner settings

| Broadcast band              | BAND[2:0] | M  | FREF[2:0] | f <sub>ref</sub> | LOINJ | Tuning step |
|-----------------------------|-----------|----|-----------|------------------|-------|-------------|
| Europe FM and US FM         | 001       | 2  | 000       | 100 kHz          | 0     | 50 kHz      |
| Japan FM                    | 010       | 3  | 000       | 100 kHz          | 1     | 33.3 kHz    |
| Eastern Europe FM (OIRT FM) | 010       | 3  | 011       | 20 kHz           | 1     | 6.67 kHz    |
| AM MW and LW                | 111       | 20 | 011       | 20 kHz           | 0     | 1 kHz       |
| AM SW 120 m to 60 m         | 110       | 16 | 100       | 10 kHz           | 0     | 0.625 kHz   |
| AM SW 49 m to 22 m          | 101       | 10 | 100       | 10 kHz           | 0     | 1 kHz       |
| AM SW 25 m to 15 m          | 100       | 8  | 100       | 10 kHz           | 0     | 1.25 kHz    |
| AM SW 16 m to 11 m          | 011       | 6  | 100       | 10 kHz           | 0     | 1.67 kHz    |

### 8.2.8 Write mode: data byte LEVELALGN

Table 42. LEVELALGN - format of data byte 06h with default setting

| 7    | 6    | 5    | 4    | 3    | 2    | 1    | 0    |
|------|------|------|------|------|------|------|------|
| LST4 | LST3 | LST2 | LST1 | LST0 | LSL2 | LSL1 | LSL0 |
| 1    | 0    | 0    | 0    | 0    | 1    | 0    | 0    |

Table 43. LEVELALGN - data byte 06h bit description

| Bit    | Symbol   | Description                   |
|--------|----------|-------------------------------|
| 7 to 3 | LST[4:0] | level start voltage alignment |
| 2 to 0 | LSL[2:0] | level slope alignment         |

For I<sup>2</sup>C-bus reading of the level voltage and standard alignment see read data byte 1 (see [Table 10](#)).

Level alignment should begin with slope alignment (LSL): the level slope does not change with level start alignment (LST) or broadcast band; therefore a single LSL alignment setting can be used for all FM and AM band selections.

Level start may change between broadcast bands; therefore generally a separate LST alignment and setting is used for every broadcast band.

### 8.2.9 Write mode: data byte IFCF

Table 44. IFCF - format of data byte 07h with default setting

| 7     | 6     | 5     | 4     | 3     | 2     | 1     | 0     |
|-------|-------|-------|-------|-------|-------|-------|-------|
| IFCFA | IFNBW | IFCF5 | IFCF4 | IFCF3 | IFCF2 | IFCF1 | IFCF0 |
| 0     | 0     | 1     | 0     | 0     | 0     | 0     | 0     |

Table 45. IFCF - data byte 07 bit description

| Bit    | Symbol    | Description   |
|--------|-----------|---|
| 7      | IFCFA     | FM IF filter align mode<br>0 = normal operation<br>1 = align mode (fast frequency settling)   |
| 6      | IFNBW     | FM IF filter narrow<br>0 = normal operation<br>1 = FM IF filter at minimum bandwidth (57 kHz) |
| 5 to 0 | IFCF[5:0] | FM IF filter center frequency alignment   |

### 8.2.10 Write mode: data byte IFCAP

Table 46. IFCAP - format of data byte 08h with default setting

| 7      | 6 | 5 | 4 | 3      | 2      | 1      | 0      |
|--------|---|---|---|--------|--------|--------|--------|
| IFCAPA | 0 | 0 | 0 | IFCAP3 | IFCAP2 | IFCAP1 | IFCAP0 |
| 0      |   |   |   | 1      | 0      | 0      | 0      |



Table 47. IFCAP - data byte 08h bit description

| Bit    | Symbol     | Description  |
|--------|------------|--|
| 7      | IFCAPA     | FM IF filter capacitor align<br>0 = standard operation<br>1 = align mode and initialization mode (auto correct disabled)   |
| 6 to 4 | -          | reserved; 0 = normal operation   |
| 3 to 0 | IFCAP[3:0] | IF filter capacitor. Setting of FM IF filter capacitor value by means of bit IFCAPG of read data byte 5, ID; see <a href="#">Table 19</a> (For initialization set IFCAPA = 1. For alignment set IFCAPA = 1 and check, when read bit IFCAPG changes from logic 0 to logic 1). |

The fully integrated IF2 filter of the TEF6901A has to be aligned in order to achieve the optimum performance at all ambient conditions.

#### 8.2.10.1 Factory alignment of bits IFCAP[3:0]

FM IF filter operation point alignment: data byte IFCAP: a single alignment of the FM IF filter operation range secures an accurate and continuous frequency setting over the full temperature range and all FM bands.

1. Set bit IFCAPA to logic 1 to disable internal IFCAP control
2. Decrease IFCAP from 15 downwards until I<sup>2</sup>C-bus read bit IFCAPG (read byte 5; ID) changes from logic 1 to logic 0
3. Save this IFCAP setting as alignment value
4. Set bit IFCAPA to logic 0 to return to normal operation

#### 8.2.10.2 Initialization of the radio

During radio initialization bit IFCAPA (is logic 1) is used for writing the stored IFCAP[3:0] value. Afterwards set bit IFCAPA to a logic 0 to start normal operation. Writing of the IFCAP byte with the alignment value is allowed during radio operation but requires a setting of bit IFCAPA to logic 0.

#### 8.2.10.3 Factory alignment of IFCF

FM IF filter center frequency alignment: data byte IFCF: to correct IF frequency errors caused by an error in the crystal frequency the alignment is preferably performed for every FM band in use. A test frequency in the center of the band is preferred. An accurate alignment result is realized by testing for symmetrical filter attenuation.

1. Set RF generator level  $V_{RF} = 200 \mu V$
2. Set bit IFCFA to logic 1 to enable fast settling of the filter frequency
3. Set bit IFNBW to logic 1 for accuracy (filter is set to narrow 57 kHz bandwidth)
4. Test high side of filter curve: tune to  $f_{RF} - 50 \text{ kHz}$  (Europe/USA) or  $f_{RF} + 33.3 \text{ kHz}$  (Japan/OIRT)
5. Change IFCF from 0 to 63 and note the level read result (level voltages)
6. Test low side of filter curve: tune to  $f_{RF} + 50 \text{ kHz}$  (Europe/USA) or  $f_{RF} - 33.3 \text{ kHz}$  (Japan/OIRT)
7. Change IFCF from 0 to 63 and note the level voltages
8. Find the IFCF value where both level curves cross (lowest difference) and save this IFCF value

9. Set bits IFCFA and IFNBW to logic 0 to return to normal operation

The bits IFCFA and IFNBW are intended for factory alignment use only. Normal radio operation requires a setting of bits IFCFA and IFNBW to logic 0.

### 8.2.11 Write mode: data byte ACD

**Table 48. ACD - format of data byte 09h with default setting**

| 7      | 6       | 5       | 4       | 3       | 2       | 1       | 0     |
|--------|---------|---------|---------|---------|---------|---------|-------|
| ACDLEV | ACDLAP1 | ACDLAP0 | ACDBAL1 | ACDBAL0 | ACDWAM1 | ACDWAM0 | HCSFH |
| 0      | 1       | 0       | 0       | 1       | 0       | 1       | 0     |

**Table 49. ACD - data byte 09h bit description**

| Bit     | Symbol      | Description  |
|---------|-------------|--|
| 7       | ACDLEV      | level threshold; start level of threshold extension and latch protection<br>0 = start at LEV = 40 ( $V_{LEVEL} = 0.88$ V), normal operation<br>1 = start at LEV = 48 ( $V_{LEVEL} = 1$ V)  |
| 6 and 5 | ACDLAP[1:0] | latch protection limit; protect against narrow bandwidth locking at high modulation, low RF signal condition<br>00 = no protection<br>01 = low protection<br>10 = standard protection<br>11 = high protection  |
| 4 and 3 | ACDBAL[1:0] | control balance; bandwidth control priority towards adjacent channel (prevent breakthrough) or towards modulation (low distortion)<br>00 = high adjacent channel priority<br>01 = medium adjacent channel priority, standard operation<br>10 = medium modulation priority<br>11 = high modulation priority |
| 2 and 1 | ACDWAM[1:0] | WAM threshold; desensitize bandwidth control at detection of WAM<br>00 = no desensitization on WAM<br>01 = low sensitivity<br>10 = medium sensitivity<br>11 = high sensitivity   |
| 0       | HCSFH       | HCC minimum bandwidth; combined control with bit HCSF; see <a href="#">Table 57</a> , <a href="#">Table 60</a> and <a href="#">Figure 26</a><br>0 = minimum bandwidth of high cut control is 2.2 kHz or 3.3 kHz<br>1 = minimum bandwidth of high cut control is 3.9 kHz or 5.6 kHz                         |

### 8.2.12 Write mode: data byte SENSE

**Table 50. SENSE - format of data byte 0Ah with default setting**

| 7    | 6    | 5    | 4    | 3    | 2    | 1    | 0    |
|------|------|------|------|------|------|------|------|
| CSA3 | CSA2 | CSA1 | CSA0 | USS1 | USS0 | WAS1 | WAS0 |
| 1    | 0    | 0    | 0    | 0    | 1    | 0    | 1    |

**Table 51. SENSE - data byte 0Ah bit description**

| Bit     | Symbol   | Description   |
|---------|----------|---|
| 7 to 4  | CSA[3:0] | alignment of FM stereo channel separation   |
| 3 and 2 | USS[1:0] | USN sensitivity; USN weak signal control equivalent level voltage/frequency deviation for weak signal processing; see <a href="#">Figure 24</a><br>00 = -0.06 V/kHz<br>01 = -0.08 V/kHz<br>10 = -0.12 V/kHz<br>11 = -0.16 V/kHz |
| 1 and 0 | WAS[1:0] | WAM sensitivity; WAM weak signal control equivalent level voltage/V <sub>LEVEL</sub> (peak-to-peak) for weak signal processing; see <a href="#">Figure 24</a><br>00 = -7.5<br>01 = -10<br>10 = -15<br>11 = -20                  |

The input control value for weak signal control derived from USN is denoted by  $V_{eq.LEVEL}$ ; equivalent level voltage. This indicates a weak signal control amount equal to the weak signal control generated by a certain  $V_{LEVEL}$  voltage.

The USS setting does not influence the I<sup>2</sup>C-bus read quality information of USN; read data byte 2, USN/WAM; see [Table 12](#).

The input control value for weak signal control derived from WAM is denoted by  $V_{eq.LEVEL}$ ; equivalent level voltage. This indicates a weak signal control amount equal to the weak signal control generated by a certain  $V_{LEVEL}$  voltage.

The WAS setting does not influence the I<sup>2</sup>C-bus read quality information of WAM; read data byte 2, USN/WAM; see [Table 12](#).

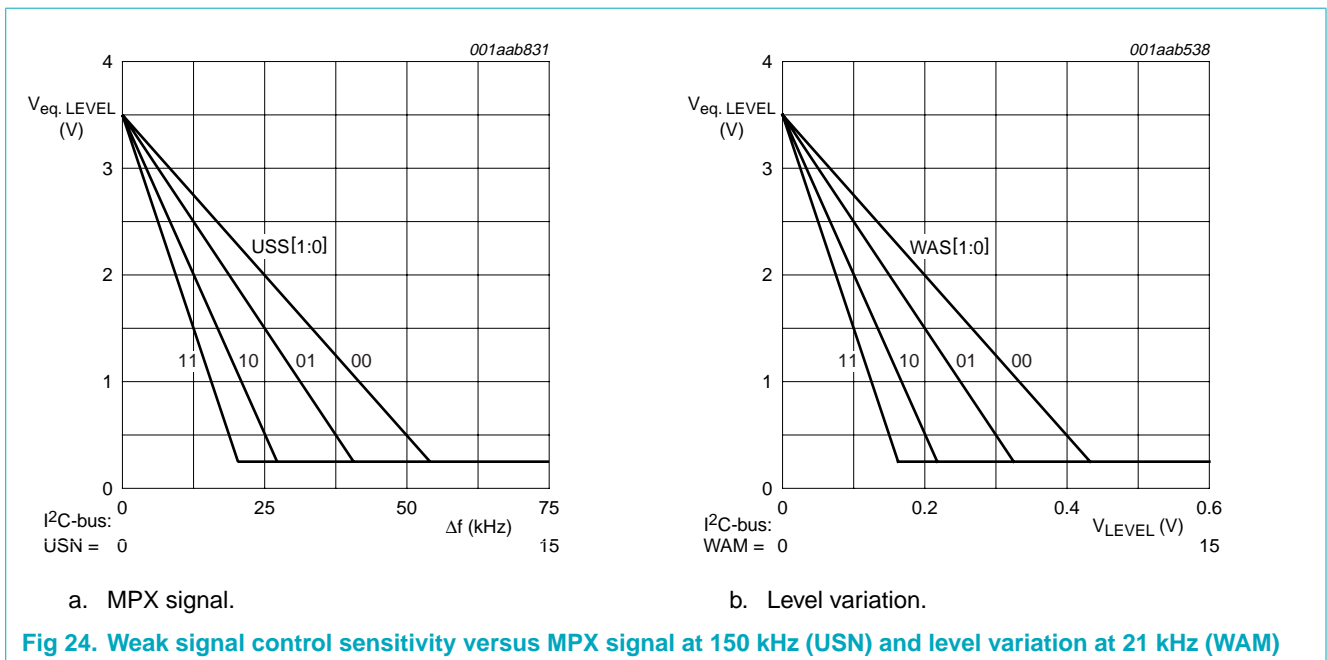

## 8.2.13 Write mode: data byte TIMING

Table 52. TIMING - format of data byte 0Bh with default setting

| 7    | 6    | 5    | 4    | 3    | 2    | 1    | 0    |
|------|------|------|------|------|------|------|------|
| STC1 | STC0 | HTC2 | HTC1 | HTC0 | MTC2 | MTC1 | MTC0 |
| 1    | 0    | 1    | 0    | 0    | 1    | 1    | 0    |

Table 53. TIMING - data byte 0Bh bit description<sup>[1]</sup>

| Bit     | Symbol   | Description  |
|---------|----------|--|
| 7 and 6 | STC[1:0] | setting of the stereo noise control time constants; see <a href="#">Table 54</a> |
| 5 to 3  | HTC[2:0] | setting of the high cut control time constants; see <a href="#">Table 55</a>     |
| 2 to 0  | MTC[2:0] | setting of the soft mute control time constants; see <a href="#">Table 56</a>    |

[1] During the tuning mute of the preset and search mode tuning action the time constants set by STC, HTC and MTC change to  $t_{\text{attack}} = 50 \text{ ms}$  and  $t_{\text{recovery}} = 50 \text{ ms}$  to enable fast settling of the weak signal processing to new conditions.

Table 54. SNC weak signal processing control speed setting

| STC1 | STC0 | $t_{\text{attack}}$ | $t_{\text{recovery}}$ |
|------|------|---------------------|-----------------------|
| 0    | 0    | 0.1 s               | 1.25 s                |
| 0    | 1    | 0.1 s               | 2.5 s                 |
| 1    | 0    | 0.1 s               | 5 s                   |
| 1    | 1    | 0.1 s               | 10 s                  |

Table 55. HCC speed setting<sup>[1]</sup>

| HTC2 | HTC1 | HTC0 | $t_{\text{attack}}$ | $t_{\text{recovery}}$ |
|------|------|------|---------------------|-----------------------|
| 0    | 0    | 0    | 0.03 s              | 0.04 s                |
| 0    | 0    | 1    | 0.03 s              | 0.08 s                |
| 0    | 1    | 0    | 0.06 s              | 0.3 s                 |
| 0    | 1    | 1    | 0.25 s              | 0.3 s                 |
| 1    | 0    | 0    | 0.25 s              | 0.6 s                 |
| 1    | 0    | 1    | 0.5 s               | 0.6 s                 |
| 1    | 1    | 0    | 1 s                 | 1.25 s                |
| 1    | 1    | 1    | 1 s                 | 2.5 s                 |

[1] When for an external audio source VU-meter mode is enabled (bits AVUM or COMP are logic 1) the HTC setting controls the  $t_{\text{recovery}}$  VU-meter timing,  $t_{\text{attack}}$  has a fixed value of 20 ms; see [Table 99](#).

Table 56. Soft mute weak signal processing control speed setting<sup>[1]</sup>

| MTC2 | MTC1 | MTC0 | t <sub>attack</sub> <sup>[2]</sup> | t <sub>recovery</sub> <sup>[3]</sup> |
|------|------|------|------------------------------------|--------------------------------------|
| 0    | 0    | 0    | 0.01 s                             | 0.01 s                               |
| 0    | 0    | 1    | 0.01 s                             | 0.03 s                               |
| 0    | 1    | 0    | 0.03 s                             | 0.1 s                                |
| 0    | 1    | 1    | 0.1 s                              | 0.1 s                                |
| 1    | 0    | 0    | 0.1 s                              | 0.2 s                                |
| 1    | 0    | 1    | 0.2 s                              | 0.2 s                                |
| 1    | 1    | 0    | 0.4 s                              | 0.4 s                                |
| 1    | 1    | 1    | 0.4 s                              | 0.8 s                                |

[1] When for an external audio source dynamic compression is enabled (bit COMP is logic 1) the MTC setting controls the t<sub>recovery</sub> compression timing, t<sub>attack</sub> has a fixed value of 20 ms; see [Table 80](#).

[2] The attack time is the time, which the weak signal processing needs to realize a full control change for a level voltage change between HIGH level (where the weak signal processing is inactive) and 0.75 V level voltage.

[3] The recovery time is the time needed for the full control change when the level voltage rises from 0.75 V to HIGH level.

### 8.2.14 Write mode: data byte SNC

Table 57. SNC - format of data byte 0Ch with default setting

| 7    | 6    | 5    | 4    | 3    | 2    | 1    | 0    |
|------|------|------|------|------|------|------|------|
| SST3 | SST2 | SST1 | SST0 | SSL1 | SSL0 | HCMP | HCSF |
| 0    | 1    | 1    | 1    | 0    | 1    | 0    | 0    |

Table 58. SNC - data byte 0Ch bit description

| Bit     | Symbol   | Description   |
|---------|----------|---|
| 7 to 4  | SST[3:0] | SNC start; start setting of the stereo noise control; see <a href="#">Table 59</a> and <a href="#">Figure 25</a>  |
| 3 and 2 | SSL[1:0] | SNC slope; slope setting of the stereo noise control ( $\alpha_{sep}/V_{eq,LEVEL}$ ); see <a href="#">Figure 25</a><br>00 = 38 dB/V<br>01 = 51 dB/V<br>10 = 63 dB/V<br>11 = 72 dB/V |
| 1       | HCMP     | HCC control source<br>0 = high cut control is only controlled by the level information<br>1 = high cut control is controlled by level, USN and WAM                                  |
| 0       | HCSF     | HCC minimum bandwidth; combined control with bit HCSFH; see <a href="#">Table 49</a> , <a href="#">Table 60</a> and <a href="#">Figure 26</a>                                       |

Table 59. Start of stereo noise control weak signal processing

| SST3 | SST2 | SST1 | SST0 | Stereo noise control start ( $V_{eq,LEVEL}$ ) |
|------|------|------|------|---|
| 0    | 0    | 0    | 0    | 1.88 V  |
| 0    | 0    | 0    | 1    | 1.94 V  |
| 0    | 0    | 1    | 0    | 2.00 V  |
| 0    | 0    | 1    | 1    | 2.06 V  |
| 0    | 1    | 0    | 0    | 2.13 V  |
| 0    | 1    | 0    | 1    | 2.19 V  |
| 0    | 1    | 1    | 0    | 2.25 V  |
| 0    | 1    | 1    | 1    | 2.31 V  |
| 1    | 0    | 0    | 0    | 2.38 V  |
| 1    | 0    | 0    | 1    | 2.44 V  |
| 1    | 0    | 1    | 0    | 2.5 V   |
| 1    | 0    | 1    | 1    | 2.56 V  |
| 1    | 1    | 0    | 0    | 2.63 V  |
| 1    | 1    | 0    | 1    | 2.69 V  |
| 1    | 1    | 1    | 0    | 2.75 V  |
| 1    | 1    | 1    | 1    | 2.81 V  |

Table 60. HCC minimum bandwidth

| HCSFH | HCSF | High cut control minimum bandwidth |
|-------|------|------------------------------------|
| 0     | 0    | 2.2 kHz                            |
| 0     | 1    | 3.3 kHz                            |
| 1     | 0    | 3.9 kHz                            |
| 1     | 1    | 5.6 kHz                            |

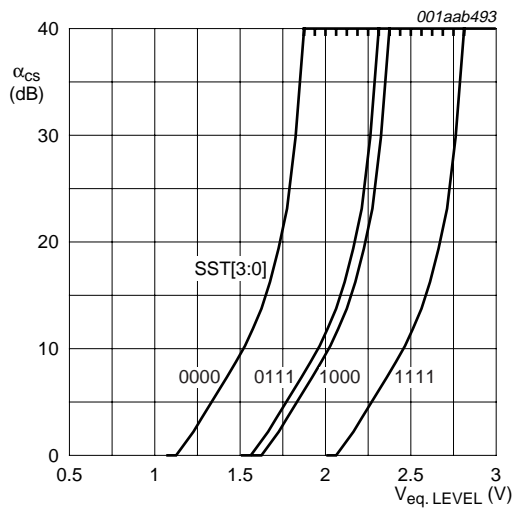

SSL = 63 dB/V.

a. Start.

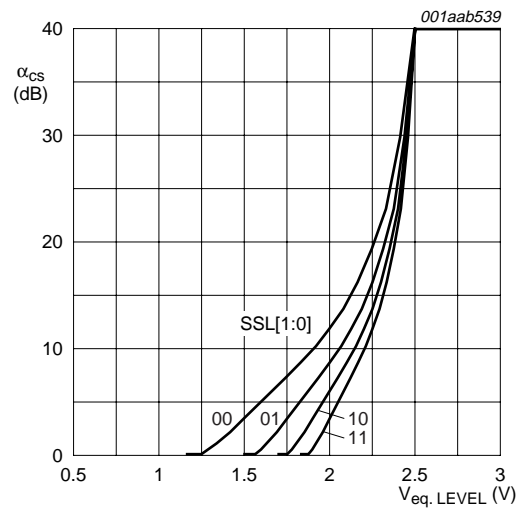

SST = 2.5 V.

b. Slope.

Fig 25. Stereo Noise Control (SNC) start and slope settings versus equivalent level voltage; SNC detector (level, USN and WAM), USN detector and WAM detector

### 8.2.15 Write mode: data byte HIGHCUT

Table 61. HIGHCUT - format of data byte 0Dh with default setting

| 7    | 6    | 5    | 4    | 3    | 2    | 1    | 0    |
|------|------|------|------|------|------|------|------|
| HST2 | HST1 | HST0 | HSL1 | HSL0 | HCF2 | HCF1 | HCF0 |
| 0    | 1    | 1    | 0    | 1    | 1    | 1    | 1    |

Table 62. HIGHCUT - data byte 0Dh bit description

| Bit     | Symbol   | Description   |
|---------|----------|---|
| 7 to 5  | HST[2:0] | HCC start; start setting of the high cut control; see <a href="#">Table 63</a> and <a href="#">Figure 26</a>  |
| 4 and 3 | HSL[1:0] | HCC slope; slope setting of the high cut control ( $\alpha_{10 \text{ kHz}/V_{\text{eq.LEVEL}}$ ); see <a href="#">Figure 26</a><br>00 = 9 dB/V<br>01 = 11 dB/V<br>10 = 14 dB/V<br>11 = 18 dB/V |
| 2 to 0  | HCF[2:0] | HCC maximum bandwidth; setting of the fixed high cut control; see <a href="#">Table 64</a> , <a href="#">Figure 26</a> and <a href="#">Figure 27</a>  |

Table 63. Start of high cut control weak signal processing

| HST2 | HST1 | HST0 | High cut control start ( $V_{eq.LEVEL}$ ) |
|------|------|------|---|
| 0    | 0    | 0    | 1.5 V                                     |
| 0    | 0    | 1    | 1.75 V                                    |
| 0    | 1    | 0    | 2.0 V                                     |
| 0    | 1    | 1    | 2.25 V                                    |
| 1    | 0    | 0    | 2.5 V                                     |
| 1    | 0    | 1    | 3.0 V                                     |
| 1    | 1    | 0    | 3.5 V                                     |
| 1    | 1    | 1    | 4.0 V                                     |

Table 64. Fixed high cut settings

| HCF2 | HCF1 | HCF0 | Fixed high cut; HCC $B_{max}$ |
|------|------|------|-------------------------------|
| 0    | 0    | 0    | reserved                      |
| 0    | 0    | 1    | 2 kHz                         |
| 0    | 1    | 0    | 3 kHz                         |
| 0    | 1    | 1    | 5 kHz                         |
| 1    | 0    | 0    | 7 kHz                         |
| 1    | 0    | 1    | 10 kHz                        |
| 1    | 1    | 0    | wide bandwidth                |
| 1    | 1    | 1    | full bandwidth                |



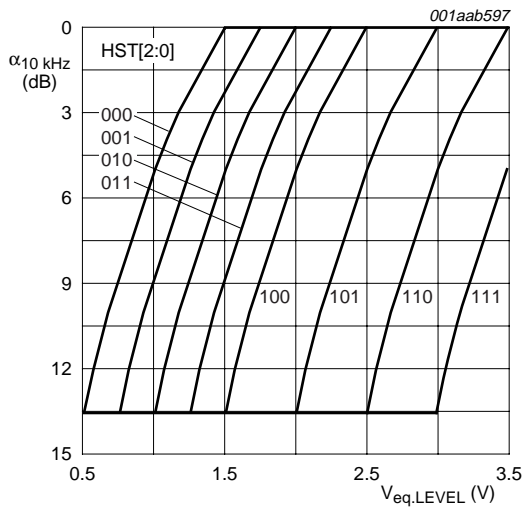

HCF = 111, HCSF = 0, HCSFH = 0, HSL = 10.

a. Start.

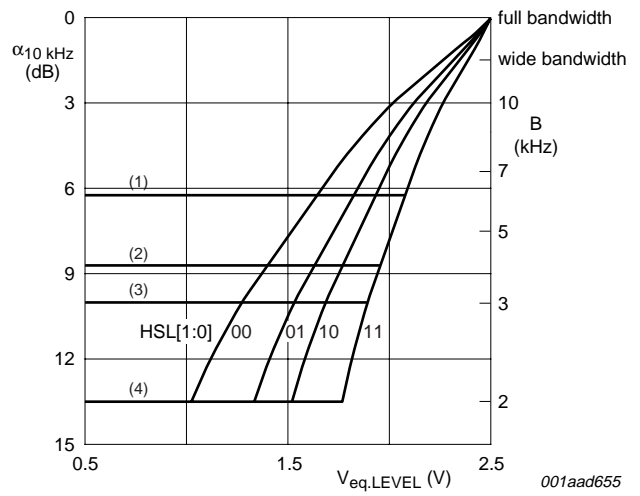

HST = 100.

- (1) HCSFH = 1; HCSF = 1;  $B_{min} = 5.6$  kHz.
- (2) HCSFH = 1; HCSF = 0;  $B_{min} = 3.9$  kHz.
- (3) HCSFH = 0; HCSF = 1;  $B_{min} = 3.3$  kHz.
- (4) HCSFH = 0; HCSF = 0;  $B_{min} = 2.2$  kHz.

b. Slope and minimum bandwidth.

Fig 26. High cut control start and slope settings versus equivalent level voltage; HCC detector (HCMP = 0 for level or HCMP = 1 for level, WAM and USN)

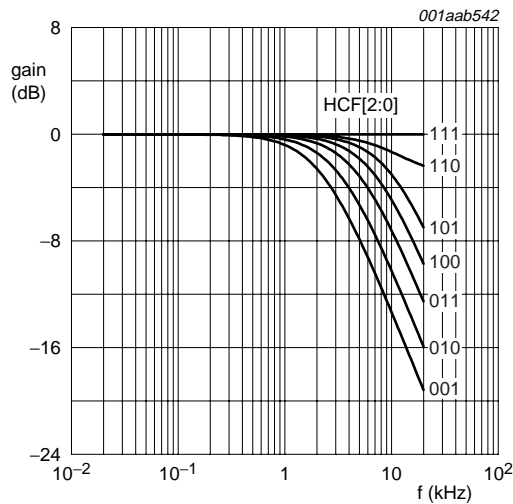

Fig 27. Fixed high cut setting characteristics

## 8.2.16 Write mode: data byte SOFTMUTE

Table 65. SOFTMUTE - format of data byte 0Eh with default setting

| 7    | 6    | 5    | 4    | 3    | 2    | 1    | 0    |
|------|------|------|------|------|------|------|------|
| MST2 | MST1 | MST0 | MSL1 | MSL0 | UMD1 | UMD0 | MSLE |
| 0    | 1    | 1    | 0    | 1    | 0    | 1    | 0    |

Table 66. SOFTMUTE - data byte 0Eh bit description

| Bit     | Symbol   | Description   |
|---------|----------|---|
| 7 to 5  | MST[2:0] | soft mute start; start setting of the soft mute; for FM see <a href="#">Table 67</a> and <a href="#">Figure 28</a> ; for AM see <a href="#">Table 68</a> and <a href="#">Figure 29</a>  |
| 4 and 3 | MSL[1:0] | soft mute slope <sup>[1]</sup> ; slope setting of the soft mute ( $\alpha_{10\text{ kHz}}/V_{\text{eq.LEVEL}}$ ); for FM see <a href="#">Table 69</a> and see <a href="#">Figure 28</a> ; for AM see <a href="#">Table 70</a> and <a href="#">Figure 29</a> |
| 2 and 1 | UMD[1:0] | USN soft mute depth; setting of the maximum attenuation of the USN fast soft mute control; see <a href="#">Figure 30</a><br>00 = 3 dB<br>01 = 6 dB<br>10 = 9 dB<br>11 = 12 dB   |
| 0       | MSLE     | soft mute slope extension; additional slope setting of the soft mute; for FM see <a href="#">Table 69</a> and <a href="#">Figure 28</a> ; for AM see <a href="#">Table 70</a> and <a href="#">Figure 29</a>   |

[1] When for an external audio source dynamic compression is enabled (bit COMP is logic 1) the MSL setting controls the compression ratio. For default 2 : 1 compression MSL = 01 is used; see [Table 82](#).

Table 67. Start of soft mute control weak signal processing; FM mode<sup>[1]</sup>

| MST2 | MST1 | MST0 | Soft mute control start ( $V_{\text{eq.LEVEL}}$ ) |
|------|------|------|---|
| 0    | 0    | 0    | 0.88 V  |
| 0    | 0    | 1    | 1.0 V   |
| 0    | 1    | 0    | 1.12 V  |
| 0    | 1    | 1    | 1.25 V  |
| 1    | 0    | 0    | 1.38 V  |
| 1    | 0    | 1    | 0.75 V  |
| 1    | 1    | 0    | 0.81 V  |
| 1    | 1    | 1    | 0.94 V  |

[1] When for an external audio source dynamic compression is enabled (COMP = 1) the MST setting controls the compression range. For default full compression MST = 7 is used; see [Table 81](#).

**Table 68. Start of soft mute control weak signal processing; AM mode<sup>[1]</sup>**

| MST2 | MST1 | MST0 | Soft mute control start ( $V_{eq.LEVEL}$ ) |
|------|------|------|--|
| 0    | 0    | 0    | 1.5 V                                      |
| 0    | 0    | 1    | 1.75 V                                     |
| 0    | 1    | 0    | 2.0 V                                      |
| 0    | 1    | 1    | 1.25 V                                     |
| 1    | 0    | 0    | 1.38 V                                     |
| 1    | 0    | 1    | 1.62 V                                     |
| 1    | 1    | 0    | 1.88 V                                     |
| 1    | 1    | 1    | 2.12 V                                     |

[1] When for an external audio source dynamic compression is enabled (COMP = 1) the MST setting controls the compression range. For default full compression MST = 7 is used; see [Table 81](#).

**Table 69. Slope of soft mute control weak signal processing; FM mode<sup>[1]</sup>**

| MSLE | MSL1 | MSL0 | Soft mute control slope ( $\alpha_{AF}/V_{eq.LEVEL}$ ) |
|------|------|------|--|
| 0    | 0    | 0    | 8 dB/V   |
| 0    | 0    | 1    | 16 dB/V  |
| 0    | 1    | 0    | 24 dB/V  |
| 0    | 1    | 1    | 32 dB/V  |
| 1    | 0    | 0    | 40 dB/V  |
| 1    | 0    | 1    | 48 dB/V  |
| 1    | 1    | 0    | reserved   |
| 1    | 1    | 1    | reserved   |

[1] When for an external audio source dynamic compression is enabled (COMP = 1) the MSL setting controls the compression range. For default 2 : 1 compression MSL = 1 is used; see [Table 82](#).

**Table 70. Slope of soft mute control weak signal processing; AM mode<sup>[1]</sup>**

| MSL1 | MSL0 | MSLE | Soft mute control slope ( $\alpha_{AF}/V_{eq.LEVEL}$ ) |
|------|------|------|--|
| 0    | 0    | 0    | 8 dB/V   |
| 0    | 0    | 1    | 12 dB/V  |
| 0    | 1    | 0    | 16 dB/V  |
| 0    | 1    | 1    | 20 dB/V  |
| 1    | 0    | 0    | 24 dB/V  |
| 1    | 0    | 1    | 28 dB/V  |
| 1    | 1    | 0    | 32 dB/V  |
| 1    | 1    | 1    | 36 dB/V  |

[1] When for an external audio source dynamic compression is enabled (COMP = 1) the MSL setting controls the compression range. For default 2 : 1 compression MSL = 1 is used; see [Table 82](#).

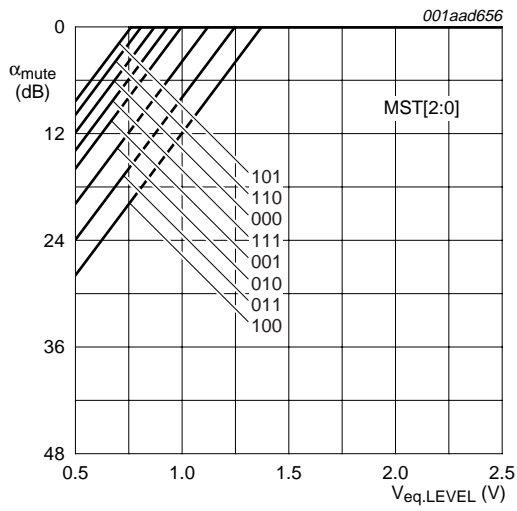

MSL[1:0] = 11.

a. Start.

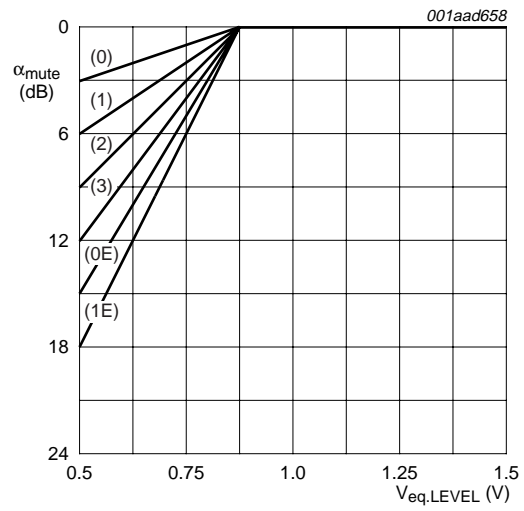

MST[2:0] = 000.

(0) MSLE = 0; MSL[1:0] = 00.

(1) MSLE = 0; MSL[1:0] = 01.

(2) MSLE = 0; MSL[1:0] = 10.

(3) MSLE = 0; MSL[1:0] = 11.

(0E) MSLE = 1; MSL[1:0] = 00.

(1E) MSLE = 1; MSL[1:0] = 01.

b. Slope.

Fig 28. Soft mute start and slope settings versus equivalent level voltage (FM mode)

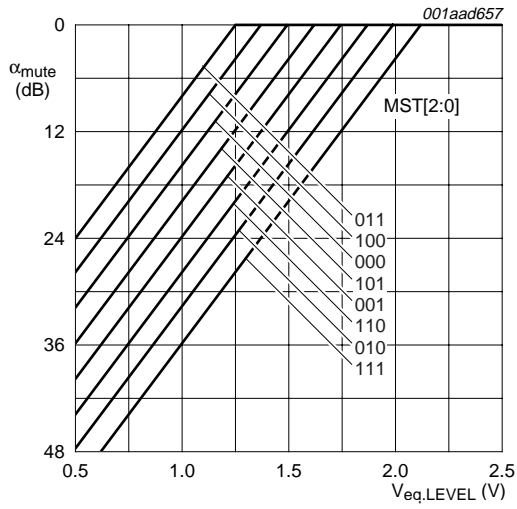

MSL[1:0] = 11.

a. Start.

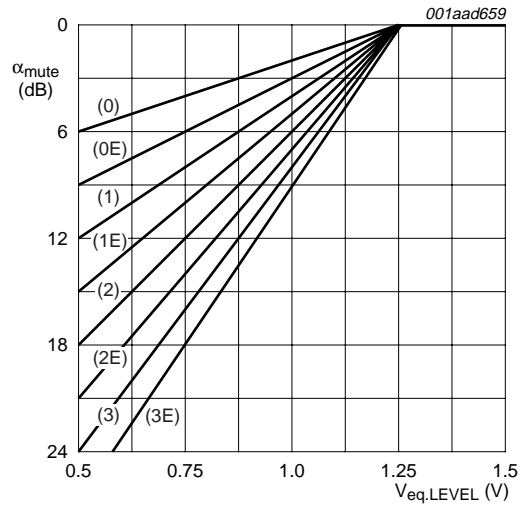

MST[2:0] = 011.

- (0) MSL[1:0] = 00; MSLE = 0.
- (0E) MSL[1:0] = 00; MSLE = 1.
- (1) MSL[1:0] = 01; MSLE = 0.
- (1E) MSL[1:0] = 01; MSLE = 1.
- (2) MSL[1:0] = 10; MSLE = 0.
- (2E) MSL[1:0] = 10; MSLE = 1.
- (3) MSL[1:0] = 11; MSLE = 0.
- (3E) MSL[1:0] = 11; MSLE = 1.

b. Slope.

Fig 29. Soft mute start and slope settings versus equivalent level voltage (AM mode)

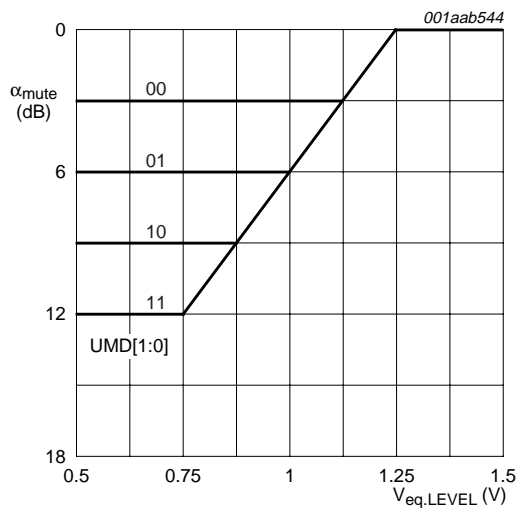

MST[2:0] = 011, MSL[1:0] = 10.

Fig 30. USN soft mute depth settings; USN detector

## 8.2.17 Write mode: data byte RADIO

Table 71. RADIO - format of data byte 0Fh with default setting

| 7 | 6    | 5    | 4    | 3    | 2    | 1    | 0    |
|---|------|------|------|------|------|------|------|
| 0 | MONO | DEMP | RDCL | NBS1 | NBS0 | NBL1 | NBL0 |
|   | 0    | 0    | 1    | 1    | 0    | 1    | 0    |

Table 72. RADIO - data byte 0Fh bit description

| Bit     | Symbol   | Description   |
|---------|----------|---|
| 7       | -        | reserved; 0 = normal operation  |
| 6       | MONO     | FM forced mono; stereo decoder disable option<br>0 = stereo decoder is set to FM stereo<br>1 = stereo decoder is set to FM mono   |
| 5       | DEMP     | de-emphasis; selection of the de-emphasis time constant; see <a href="#">Figure 31</a><br>0 = de-emphasis is 75 $\mu$ s<br>1 = de-emphasis is 50 $\mu$ s  |
| 4       | RDCL     | RDS output mode<br>0 = direct output mode; clock output and data output; see <a href="#">Figure 32</a><br>1 = buffered output mode; clock input and data output of 16-bit data buffer and optional 3-bit demodulation quality (RDQ counter); see <a href="#">Figure 33</a>  |
| 3 and 2 | NBS[1:0] | noise blanker audio sensitivity<br>FM audio noise blanker sensitivity setting of FM MPX ignition noise detector (peak value)<br>00 = 65 mV (high sensitivity)<br>01 = 100 mV<br>10 = 125 mV<br>11 = 160 mV (low sensitivity)<br>AM audio noise blanker sensitivity setting of audio ignition noise detector<br>00 = 16.5 V/ms<br>01 = 18.6 V/ms<br>10 = 21 V/ms<br>11 = 23.5 V/ms       |
| 1 and 0 | NBL[1:0] | noise blanker IF or level sensitivity<br>FM audio noise blanker sensitivity setting of FM level ignition noise detector (peak value)<br>00 = 10 mV<br>01 = 25 mV<br>10 = 36 mV<br>11 = 50 mV<br>AM IF noise blanker sensitivity setting of IF ignition noise detector<br>00 = 1.4 V (low sensitivity)<br>01 = 1 V<br>10 = 0.7 V (high sensitivity)<br>11 = AM IF noise blanker disabled |

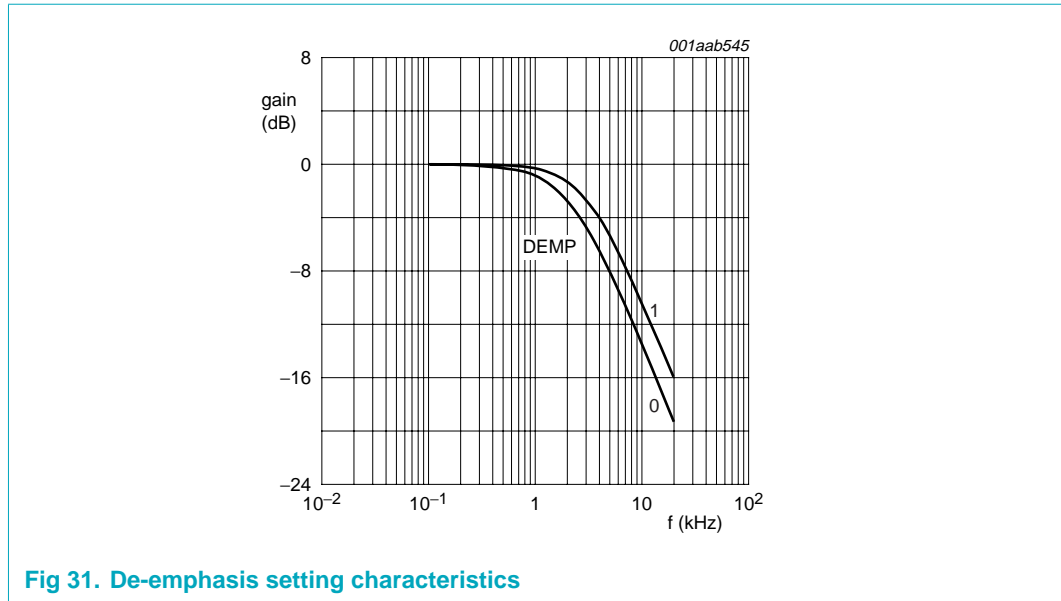

Fig 31. De-emphasis setting characteristics

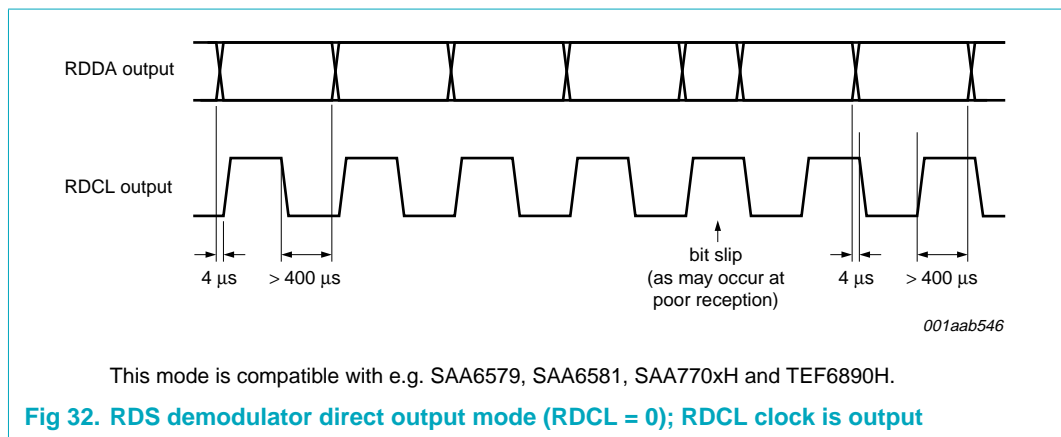
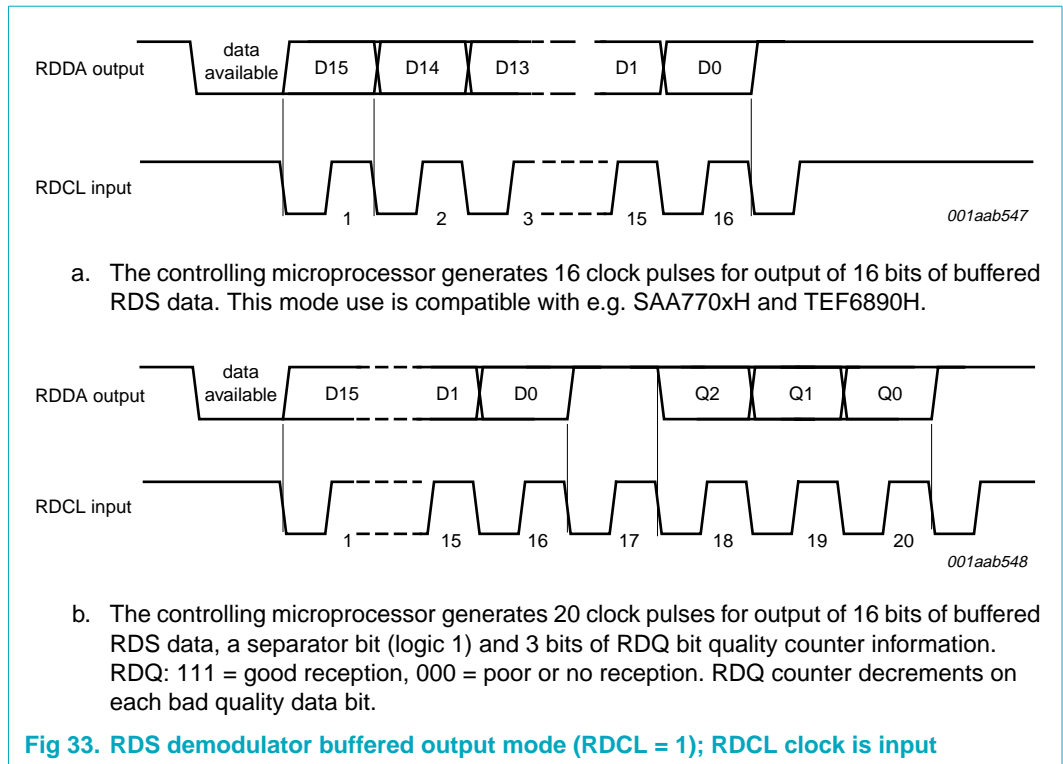

Fig 32. RDS demodulator direct output mode (RDCL = 0); RDCL clock is output



8.2.18 Write mode: data byte INPUT

Table 73. INPUT - format of data byte 10h with default setting

|      |      |      |      |      |      |      |      |
|------|------|------|------|------|------|------|------|
| 7    | 6    | 5    | 4    | 3    | 2    | 1    | 0    |
| INP3 | INP2 | INP1 | INP0 | ING3 | ING2 | ING1 | ING0 |
| 0    | 0    | 0    | 0    | 1    | 0    | 1    | 0    |

Table 74. INPUT - data byte 10h bit description

| Bit    | Symbol   | Description   |
|--------|----------|---|
| 7 to 4 | INP[3:0] | input selection; selection of the audio source for the tone/volume part; see Table 75   |
| 3 to 0 | ING[3:0] | Input gain; -10 dB to +18 dB input gain. The ING input gain setting is added to the VOL volume setting to define the actual volume control; see Table 76. |



Table 75. Input select

| INP3 | INP2 | INP1 | INP0 | Audio source for tone/volume processing         |
|------|------|------|------|---|
| 0    | 0    | 0    | 0    | radio   |
| 0    | 0    | 0    | 1    | stereo with CMR (INAL, INAR and INAC)           |
| 0    | 0    | 1    | 0    | stereo (INBL and INBR)                          |
| 0    | 0    | 1    | 1    | mono symmetrical or mono with CMR (INC and IND) |
| 0    | 1    | 0    | 0    | stereo (INC and IND)                            |
| 0    | 1    | 0    | 1    | mono (INC)                                      |
| 0    | 1    | 1    | 0    | mono (IND)                                      |
| 0    | 1    | 1    | 1    | stereo with CMR (INBL, INBR and INC)            |
| 1    | 0    | 0    | 0    | stereo symmetrical (INBL, INBR, INC and IND)    |
| 1    | 0    | 0    | 1    | stereo (INAL and INAR)                          |
| 1    | 0    | 1    | 0    | mono (INAC)                                     |
| 1    | 0    | 1    | 1    | reserved  |
| 1    | 1    | 0    | 0    | reserved  |
| 1    | 1    | 0    | 1    | reserved  |
| 1    | 1    | 1    | 0    | reserved  |
| 1    | 1    | 1    | 1    | reserved  |

Table 76. Input gain setting

| ING3 | ING2 | ING1 | ING0 | Input gain control    |
|------|------|------|------|-----------------------|
| 1    | 0    | 1    | 1    | -10 dB <sup>[1]</sup> |
| 1    | 1    | 0    | 0    | -8 dB                 |
| 1    | 1    | 0    | 1    | -6 dB                 |
| 1    | 1    | 1    | 0    | -4 dB                 |
| 1    | 1    | 1    | 1    | -2 dB                 |
| 0    | 0    | 0    | 0    | 0 dB                  |
| 0    | 0    | 0    | 1    | 2 dB                  |
| 0    | 0    | 1    | 0    | 4 dB                  |
| 0    | 0    | 1    | 1    | 6 dB                  |
| 0    | 1    | 0    | 0    | 8 dB                  |
| 0    | 1    | 0    | 1    | 10 dB <sup>[1]</sup>  |
| 0    | 1    | 1    | 0    | 12 dB <sup>[1]</sup>  |
| 0    | 1    | 1    | 1    | 14 dB <sup>[1]</sup>  |
| 1    | 0    | 0    | 0    | 16 dB <sup>[1]</sup>  |
| 1    | 0    | 0    | 1    | 18 dB <sup>[1]</sup>  |
| 1    | 0    | 1    | 0    | mute                  |

[1] The input gain setting ING and the volume setting VOL define the overall volume. The overall range is limited to -83 dB to +26 dB. For overall values > +28 dB the actual gain is +28 dB. For overall values < -83 dB the circuit is muted.

Table 77. Input select pin use and suggested combinations of input sources<sup>[1]</sup>

| INP  | Input pin use |    |     |    |    |     |    | Audio source       | Source combinations |   |   |   |   |   |   |   |
|------|---------------|----|-----|----|----|-----|----|--------------------|---------------------|---|---|---|---|---|---|---|
|      | AL            | AR | AC  | BL | BR | C   | D  |                    |                     |   |   |   |   |   |   |   |
| 0000 |               |    |     |    |    |     |    | radio              | x                   | x | x | x | x | x | x | x |
| 0001 | L             | R  | GND |    |    |     |    | stereo CMR         | x                   | x | x | x | x |   |   |   |
| 0010 |               |    |     | L  | R  |     |    | stereo             | x                   | x | x |   |   |   | x | x |
| 0011 |               |    |     |    |    | M-  | M+ | mono symmetrical   | x                   |   |   |   |   |   | x |   |
| 0100 |               |    |     |    |    | L-  | R- | stereo             |                     | x |   |   |   |   |   | x |
| 0101 |               |    |     |    |    | M-  |    | mono               |                     |   | x |   |   |   |   | x |
| 0110 |               |    |     |    |    |     | M  | mono               |                     |   | x | x |   |   |   | x |
| 0111 |               |    |     | L  | R  | GND |    | stereo CMR         |                     |   |   | x |   |   |   |   |
| 1000 |               |    |     | L+ | R+ | L-  | R- | stereo symmetrical |                     |   |   |   | x | x |   |   |
| 1001 | L             | R  |     |    |    |     |    | stereo             |                     |   |   |   |   | x | x | x |
| 1010 |               |    | M-  |    |    |     |    | mono               |                     |   |   |   |   | x | x | x |

[1] M-, L- and R- indicate inverted polarity of audio signal.

### 8.2.19 Write mode: data byte VOLUME

Table 78. VOLUME - format of data byte 11h with default setting

| 7    | 6    | 5    | 4    | 3    | 2    | 1    | 0    |
|------|------|------|------|------|------|------|------|
| COMP | VOL6 | VOL5 | VOL4 | VOL3 | VOL2 | VOL1 | VOL0 |
| 0    | 0    | 1    | 1    | 0    | 0    | 0    | 0    |

Table 79. VOLUME - data byte 11h bit description

| Bit    | Symbol   | Description   |
|--------|----------|---|
| 7      | COMP     | dynamic compression <sup>[1]</sup> ; see <a href="#">Figure 36</a><br>0 = compression is disabled (standard use)<br>1 = dynamic compression is enabled  |
| 6 to 0 | VOL[6:0] | volume setting (see <a href="#">Table 83</a> ); for balance control see data byte 16h (see <a href="#">Table 94</a> ), for loudness control see data byte 17h (see <a href="#">Table 97</a> ) |

[1] Dynamic compression can be used with external sources only. When dynamic compression is active, the radio quality detection of USN, MOD and OFFS is limited to AF update tuning only. For dynamic compression the bits MOD[4:0] indicate the external source input amplitude as in the VU-meter mode; AVUM; data byte 17h (see [Table 97](#)). The FM dynamic bandwidth control is disabled and a fixed bandwidth of 113 kHz is defined. However, other fixed bandwidth settings are available by DYN = 0 and the setting of BW; data byte 0h (see [Table 28](#)). The compression recovery timing is controlled by data byte 0Bh; TIMING (see [Table 80](#)). Compression start and slope are controlled by data byte 0Eh; SOFTMUTE (see [Table 81](#) and [Table 82](#)). Standard compression requires a setting of MST = 7 and MSL = 1.

**Table 80. Dynamic compression timing; MTC[2:0] of data byte 0Bh; TIMING<sup>[1]</sup>**

| MTC2 | MTC1 | MTC0 | t <sub>attack</sub> | t <sub>recovery</sub> |
|------|------|------|---------------------|-----------------------|
| 0    | 0    | 0    | 0.02 s              | 0.03 s                |
| 0    | 0    | 1    | 0.02 s              | 0.06 s                |
| 0    | 1    | 0    | 0.02 s              | 0.2 s                 |
| 0    | 1    | 1    | 0.02 s              | 5 s                   |
| 1    | 0    | 0    | 0.02 s              | 0.6 s                 |
| 1    | 0    | 1    | 0.02 s              | 10 s                  |
| 1    | 1    | 0    | 0.02 s              | 1 s                   |
| 1    | 1    | 1    | 0.02 s              | 2 s                   |

[1] Setting MTC is also in use for setting the timing of weak signal soft mute control during radio operation.

**Table 81. Dynamic compression start; MST[2:0] of data byte 0Eh; SOFTMUTE<sup>[1]</sup>**

| MST2 | MST1 | MST0 | Compression range                           |
|------|------|------|---|
| 0    | 0    | 0    | reserved                                    |
| 0    | 0    | 1    | reserved                                    |
| 0    | 1    | 0    | reserved                                    |
| 0    | 1    | 1    | start = 4 dBV; 2 : 1 range = 2 dB           |
| 1    | 0    | 0    | start = -4 dBV; 2 : 1 range = 6 dB          |
| 1    | 0    | 1    | start = -12 dBV; 2 : 1 range = 10 dB        |
| 1    | 1    | 0    | start = -20 dBV; 2 : 1 range = 14 dB        |
| 1    | 1    | 1    | start = -34 dBV; full range (2 : 1 = 18 dB) |

[1] Setting MST is also in use for setting the start of weak signal soft mute control during radio operation.

**Table 82. Dynamic compression slope; MSL[1:0] of data byte 0Eh; SOFTMUTE<sup>[1]</sup>**

| MSL1 | MSL0 | Compression ratio                                |
|------|------|--|
| 0    | 0    | 4 : 3; full range = 9 dB                         |
| 0    | 1    | standard compression (2 : 1); full range = 18 dB |
| 1    | 0    | 4 : 1; full range = 27 dB                        |
| 1    | 1    | limiting; full range = 36 dB                     |

[1] Setting MSL is also in use for setting the slope of weak signal soft mute control during radio operation.

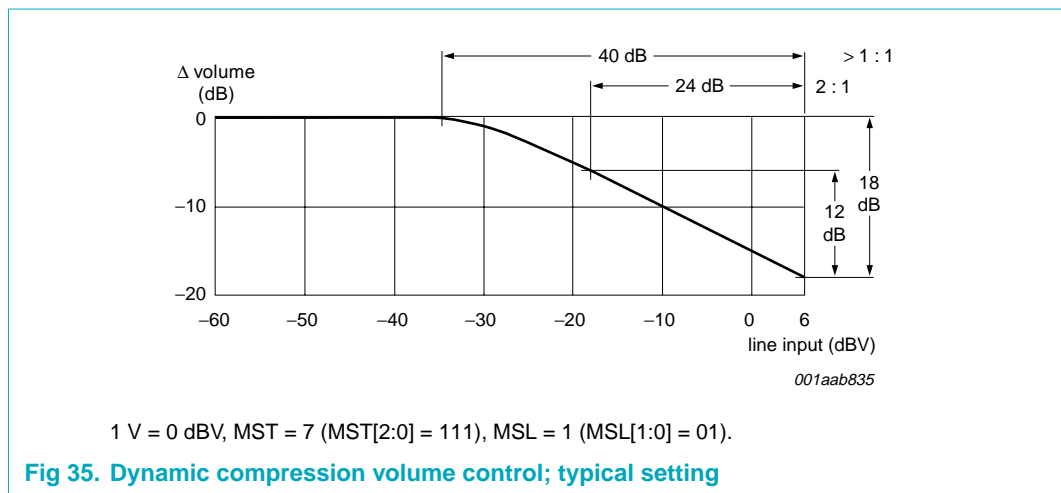
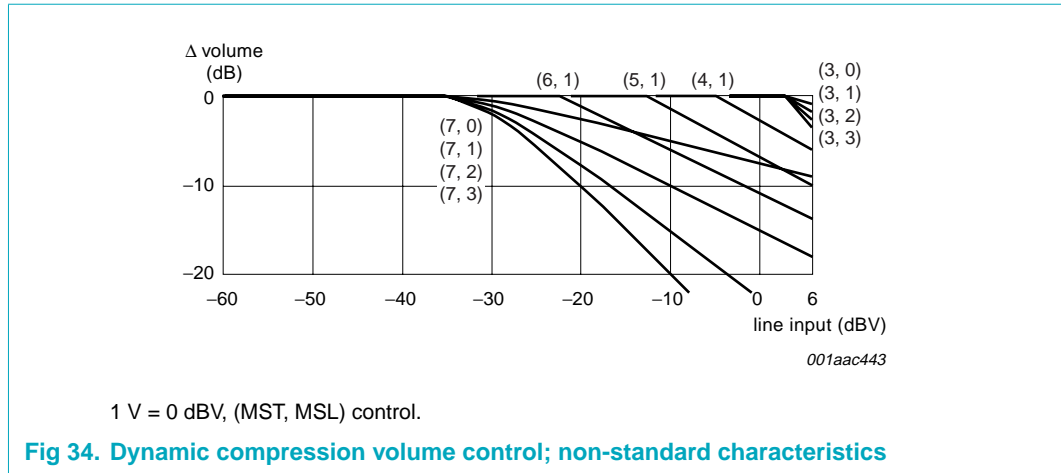

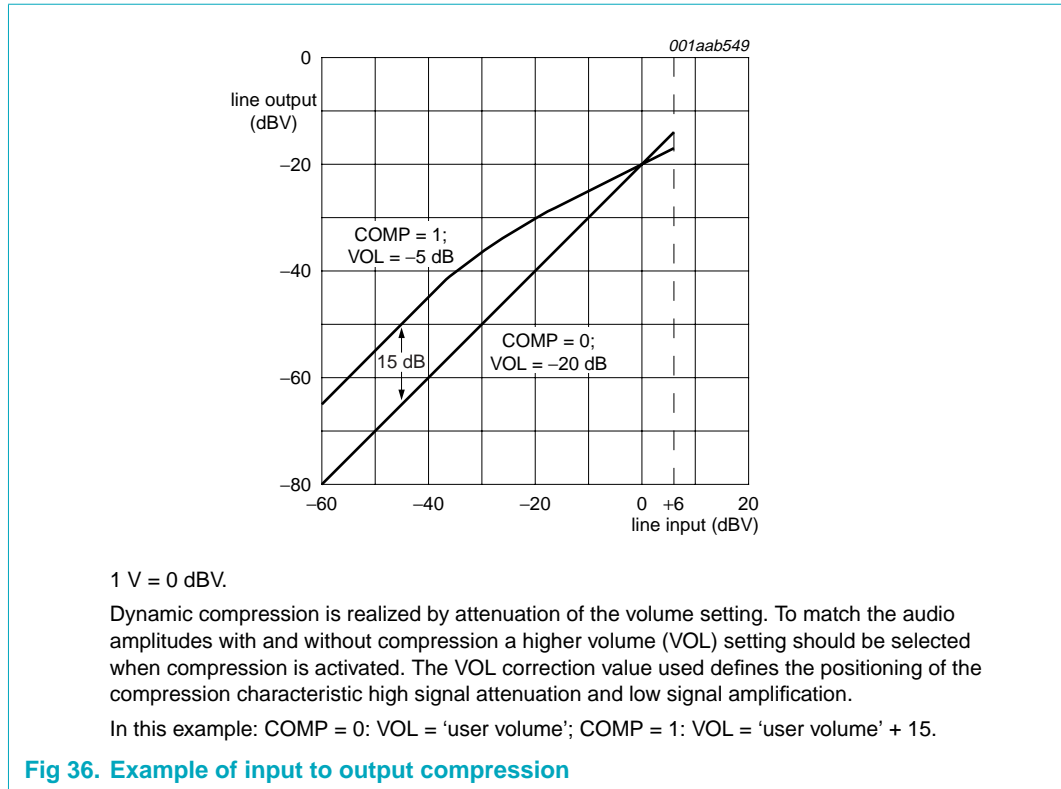

**Table 83. Volume setting**

| VOL6 | VOL5 | VOL4 | VOL3 | VOL2 | VOL1 | VOL0 | Volume (dB)       |
|------|------|------|------|------|------|------|-------------------|
| 0    | 0    | 0    | 0    | 0    | 0    | 0    | 28 <sup>[1]</sup> |
| 0    | 0    | 0    | 0    | 0    | 0    | 1    | 27 <sup>[1]</sup> |
| 0    | 0    | 0    | 0    | 0    | 1    | 0    | 26 <sup>[1]</sup> |
| 0    | 0    | 0    | 0    | 0    | 1    | 1    | 25 <sup>[1]</sup> |
| 0    | 0    | 0    | 0    | 1    | 0    | 0    | 24 <sup>[1]</sup> |
| 0    | 0    | 0    | 0    | 1    | 0    | 1    | 23 <sup>[1]</sup> |
| 0    | 0    | 0    | 0    | 1    | 1    | 0    | 22 <sup>[1]</sup> |
| 0    | 0    | 0    | 0    | 1    | 1    | 1    | 21 <sup>[1]</sup> |
| 0    | 0    | 0    | 1    | 0    | 0    | 0    | 20 <sup>[1]</sup> |
| 0    | 0    | 0    | 1    | 0    | 0    | 1    | 19 <sup>[1]</sup> |
| 0    | 0    | 0    | 1    | 0    | 1    | 0    | 18 <sup>[1]</sup> |
| 0    | 0    | 0    | 1    | 0    | 1    | 1    | 17 <sup>[1]</sup> |
| 0    | 0    | 0    | 1    | 1    | 0    | 0    | 16 <sup>[1]</sup> |
| 0    | 0    | 0    | 1    | 1    | 0    | 1    | 15 <sup>[1]</sup> |
| 0    | 0    | 0    | 1    | 1    | 1    | 0    | 14 <sup>[1]</sup> |
| 0    | 0    | 0    | 1    | 1    | 1    | 1    | 13 <sup>[1]</sup> |
| 0    | 0    | 1    | 0    | 0    | 0    | 0    | 12 <sup>[1]</sup> |
| 0    | 0    | 1    | 0    | 0    | 0    | 1    | 11 <sup>[1]</sup> |
| 0    | 0    | 1    | 0    | 0    | 1    | 0    | 10                |
| 0    | 0    | 1    | 0    | 0    | 1    | 1    | 9                 |

Table 83. Volume setting ...continued

| VOL6 | VOL5 | VOL4 | VOL3 | VOL2 | VOL1 | VOL0 | Volume (dB) |
|------|------|------|------|------|------|------|-------------|
| 0    | 0    | 1    | 0    | 1    | 0    | 0    | 8           |
| 0    | 0    | 1    | 0    | 1    | 0    | 1    | 7           |
| 0    | 0    | 1    | 0    | 1    | 1    | 0    | 6           |
| 0    | 0    | 1    | 0    | 1    | 1    | 1    | 5           |
| 0    | 0    | 1    | 1    | 0    | 0    | 0    | 4           |
| 0    | 0    | 1    | 1    | 0    | 0    | 1    | 3           |
| 0    | 0    | 1    | 1    | 0    | 1    | 0    | 2           |
| 0    | 0    | 1    | 1    | 0    | 1    | 1    | 1           |
| 0    | 0    | 1    | 1    | 1    | 0    | 0    | 0           |
| 0    | 0    | 1    | 1    | 1    | 0    | 1    | -1          |
| 0    | 0    | 1    | 1    | 1    | 1    | 0    | -2          |
| 0    | 0    | 1    | 1    | 1    | 1    | 1    | -3          |
| 0    | 1    | 0    | 0    | 0    | 0    | 0    | -4          |
| 0    | 1    | 0    | 0    | 0    | 0    | 1    | -5          |
| 0    | 1    | 0    | 0    | 0    | 1    | 0    | -6          |
| 0    | 1    | 0    | 0    | 0    | 1    | 1    | -7          |
| 0    | 1    | 0    | 0    | 1    | 0    | 0    | -8          |
| 0    | 1    | 0    | 0    | 1    | 0    | 1    | -9          |
| 0    | 1    | 0    | 0    | 1    | 1    | 0    | -10         |
| 0    | 1    | 0    | 0    | 1    | 1    | 1    | -11         |
| 0    | 1    | 0    | 1    | 0    | 0    | 0    | -12         |
| 0    | 1    | 0    | 1    | 0    | 0    | 1    | -13         |
| 0    | 1    | 0    | 1    | 0    | 1    | 0    | -14         |
| 0    | 1    | 0    | 1    | 0    | 1    | 1    | -15         |
| 0    | 1    | 0    | 1    | 1    | 0    | 0    | -16         |
| 0    | 1    | 0    | 1    | 1    | 0    | 1    | -17         |
| 0    | 1    | 0    | 1    | 1    | 1    | 0    | -18         |
| 0    | 1    | 0    | 1    | 1    | 1    | 1    | -19         |
| 0    | 1    | 1    | 0    | 0    | 0    | 0    | -20         |
| 0    | 1    | 1    | 0    | 0    | 0    | 1    | -21         |
| 0    | 1    | 1    | 0    | 0    | 1    | 0    | -22         |
| 0    | 1    | 1    | 0    | 0    | 1    | 1    | -23         |
| 0    | 1    | 1    | 0    | 1    | 0    | 0    | -24         |
| 0    | 1    | 1    | 0    | 1    | 0    | 1    | -25         |
| 0    | 1    | 1    | 0    | 1    | 1    | 0    | -26         |
| 0    | 1    | 1    | 0    | 1    | 1    | 1    | -27         |
| 0    | 1    | 1    | 1    | 0    | 0    | 0    | -28         |
| 0    | 1    | 1    | 1    | 0    | 0    | 1    | -29         |
| 0    | 1    | 1    | 1    | 0    | 1    | 0    | -30         |
| 0    | 1    | 1    | 1    | 0    | 1    | 1    | -31         |
| 0    | 1    | 1    | 1    | 1    | 0    | 0    | -32         |

Table 83. Volume setting ...continued

| VOL6 | VOL5 | VOL4 | VOL3 | VOL2 | VOL1 | VOL0 | Volume (dB)        |
|------|------|------|------|------|------|------|--------------------|
| 0    | 1    | 1    | 1    | 1    | 0    | 1    | -33                |
| 0    | 1    | 1    | 1    | 1    | 1    | 0    | -34                |
| 0    | 1    | 1    | 1    | 1    | 1    | 1    | -35                |
| 1    | 0    | 0    | 0    | 0    | 0    | 0    | -36                |
| 1    | 0    | 0    | 0    | 0    | 0    | 1    | -37                |
| 1    | 0    | 0    | 0    | 0    | 1    | 0    | -38                |
| 1    | 0    | 0    | 0    | 0    | 1    | 1    | -39                |
| 1    | 0    | 0    | 0    | 1    | 0    | 0    | -40                |
| 1    | 0    | 0    | 0    | 1    | 0    | 1    | -41                |
| 1    | 0    | 0    | 0    | 1    | 1    | 0    | -42                |
| 1    | 0    | 0    | 0    | 1    | 1    | 1    | -43                |
| 1    | 0    | 0    | 1    | 0    | 0    | 0    | -44                |
| 1    | 0    | 0    | 1    | 0    | 0    | 1    | -45                |
| 1    | 0    | 0    | 1    | 0    | 1    | 0    | -46                |
| 1    | 0    | 0    | 1    | 0    | 1    | 1    | -47                |
| 1    | 0    | 0    | 1    | 1    | 0    | 0    | -48                |
| 1    | 0    | 0    | 1    | 1    | 0    | 1    | -49                |
| 1    | 0    | 0    | 1    | 1    | 1    | 0    | -50                |
| 1    | 0    | 0    | 1    | 1    | 1    | 1    | -51                |
| 1    | 0    | 1    | 0    | 0    | 0    | 0    | -52                |
| 1    | 0    | 1    | 0    | 0    | 0    | 1    | -53                |
| 1    | 0    | 1    | 0    | 0    | 1    | 0    | -54                |
| 1    | 0    | 1    | 0    | 0    | 1    | 1    | -55                |
| 1    | 0    | 1    | 0    | 1    | 0    | 0    | -56                |
| 1    | 0    | 1    | 0    | 1    | 0    | 1    | -57 <sup>[2]</sup> |
| 1    | 0    | 1    | 0    | 1    | 1    | 0    | -58 <sup>[2]</sup> |
| 1    | 0    | 1    | 0    | 1    | 1    | 1    | -59 <sup>[2]</sup> |
| 1    | 0    | 1    | 1    | 0    | 0    | 0    | -60 <sup>[2]</sup> |
| 1    | 0    | 1    | 1    | 0    | 0    | 1    | -61 <sup>[2]</sup> |
| 1    | 0    | 1    | 1    | 0    | 1    | 0    | -62 <sup>[2]</sup> |
| 1    | 0    | 1    | 1    | 0    | 1    | 1    | -63 <sup>[2]</sup> |
| 1    | 0    | 1    | 1    | 1    | 0    | 0    | -64 <sup>[2]</sup> |
| 1    | 0    | 1    | 1    | 1    | 0    | 1    | -65 <sup>[2]</sup> |
| 1    | 0    | 1    | 1    | 1    | 1    | 0    | -66 <sup>[2]</sup> |
| 1    | 0    | 1    | 1    | 1    | 1    | 1    | -67 <sup>[2]</sup> |
| 1    | 1    | 0    | 0    | 0    | 0    | 0    | -68 <sup>[2]</sup> |
| 1    | 1    | 0    | 0    | 0    | 0    | 1    | -69 <sup>[2]</sup> |
| 1    | 1    | 0    | 0    | 0    | 1    | 0    | -70 <sup>[2]</sup> |
| 1    | 1    | 0    | 0    | 0    | 1    | 1    | -71 <sup>[2]</sup> |
| 1    | 1    | 0    | 0    | 1    | 0    | 0    | -72 <sup>[2]</sup> |
| 1    | 1    | 0    | 0    | 1    | 0    | 1    | -73 <sup>[2]</sup> |

Table 83. Volume setting ...continued

| VOL6 | VOL5 | VOL4 | VOL3 | VOL2 | VOL1 | VOL0 | Volume (dB)           |
|------|------|------|------|------|------|------|-----------------------|
| 1    | 1    | 0    | 0    | 1    | 1    | 0    | -74 <sup>[1][2]</sup> |
| 1    | 1    | 0    | 0    | 1    | 1    | 1    | -75 <sup>[1][2]</sup> |
| 1    | 1    | 0    | 1    | 0    | 0    | 0    | -76 <sup>[1][2]</sup> |
| 1    | 1    | 0    | 1    | 0    | 0    | 1    | -77 <sup>[1][2]</sup> |
| 1    | 1    | 0    | 1    | 0    | 1    | 0    | -78 <sup>[1][2]</sup> |
| 1    | 1    | 0    | 1    | 0    | 1    | 1    | -79 <sup>[1][2]</sup> |
| 1    | 1    | 0    | 1    | 1    | 0    | 0    | -80 <sup>[1][2]</sup> |
| 1    | 1    | 0    | 1    | 1    | 0    | 1    | -81 <sup>[1][2]</sup> |
| 1    | 1    | 0    | 1    | 1    | 1    | 0    | -82 <sup>[1][2]</sup> |
| 1    | 1    | 0    | 1    | 1    | 1    | 1    | -83 <sup>[1][2]</sup> |
| 1    | 1    | 1    | 0    | 0    | 0    | 0    | -84 <sup>[1][2]</sup> |
| 1    | 1    | 1    | 0    | 0    | 0    | 1    | -85 <sup>[1][2]</sup> |
| 1    | 1    | 1    | 0    | 0    | 1    | 0    | -86 <sup>[1][2]</sup> |
| 1    | 1    | 1    | 0    | 0    | 1    | 1    | -87 <sup>[1][2]</sup> |
| 1    | 1    | 1    | 0    | 1    | 0    | 0    | -88 <sup>[1][2]</sup> |
| 1    | 1    | 1    | 0    | 1    | 0    | 1    | -89 <sup>[1][2]</sup> |
| 1    | 1    | 1    | 0    | 1    | 1    | 0    | -90 <sup>[1][2]</sup> |
| 1    | 1    | 1    | 0    | 1    | 1    | 1    | -91 <sup>[1][2]</sup> |
| 1    | 1    | 1    | 1    | 0    | 0    | 0    | -92 <sup>[1][2]</sup> |
| 1    | 1    | 1    | 1    | 0    | 0    | 1    | -93 <sup>[1][2]</sup> |
| 1    | 1    | 1    | 1    | 0    | 1    | 0    | -94 <sup>[1][2]</sup> |
| 1    | 1    | 1    | 1    | 0    | 1    | 1    | -95 <sup>[1][2]</sup> |
| 1    | 1    | 1    | 1    | 1    | 0    | 0    | -96 <sup>[1][2]</sup> |
| 1    | 1    | 1    | 1    | 1    | 0    | 1    | -97 <sup>[1][2]</sup> |
| 1    | 1    | 1    | 1    | 1    | 1    | 0    | -98 <sup>[1][2]</sup> |
| 1    | 1    | 1    | 1    | 1    | 1    | 1    | mute                  |

[1] The overall gain is the sum of the input gain setting ING[3:0] and the volume setting VOL[6:0].

The overall gain has a range of +28 dB to -83 dB.

For  $ING + VOL > 28$  dB the overall gain is 28 dB.

For  $ING + VOL < -83$  dB the mute is active.

[2] For overall gain values below -75 dB ( $ING + VOL < -75$  dB) the gain steps have a monotonous sequence.

The values of gain set error, gain step error and gain tracking error are not specified. The minimum gain value is determined by the mute value.



**8.2.20 Write mode: data byte TREBLE**

**Table 84. TREBLE - format of data byte 12h with default setting**

| 7 | 6    | 5    | 4    | 3    | 2    | 1    | 0 |
|---|------|------|------|------|------|------|---|
| 0 | TRE2 | TRE1 | TRE0 | TREM | TRF1 | TRF0 | 0 |
|   | 0    | 0    | 0    | 1    | 1    | 0    |   |

**Table 85. TREBLE - data byte 12h bit description**

| Bit     | Symbol   | Description   |
|---------|----------|---|
| 7       | -        | reserved; 0 = normal operation  |
| 6 to 4  | TRE[2:0] | treble setting; treble amplification or gain setting; see <a href="#">Table 86</a> and <a href="#">Figure 37</a>  |
| 3       | TREM     | treble control mode; treble control of attenuation or gain; see <a href="#">Table 86</a><br>0 = treble mode is set to attenuation<br>1 = treble mode is set to gain |
| 2 and 1 | TRF[1:0] | treble frequency<br>00 = 8 kHz<br>01 = 10 kHz<br>10 = 12 kHz<br>11 = 15 kHz   |
| 0       | -        | reserved; 0 = normal operation  |

**Table 86. Treble control setting**

| TRE2            | TRE1 | TRE0 | Treble control |
|-----------------|------|------|----------------|
| <b>TREM = 0</b> |      |      |                |
| 0               | 0    | 0    | 0 dB           |
| 0               | 0    | 1    | -2 dB          |
| 0               | 1    | 0    | -4 dB          |
| 0               | 1    | 1    | -6 dB          |
| 1               | 0    | 0    | -8 dB          |
| 1               | 0    | 1    | -10 dB         |
| 1               | 1    | 0    | -12 dB         |
| 1               | 1    | 1    | -14 dB         |
| <b>TREM = 1</b> |      |      |                |
| 0               | 0    | 0    | 0 dB           |
| 0               | 0    | 1    | 2 dB           |
| 0               | 1    | 0    | 4 dB           |
| 0               | 1    | 1    | 6 dB           |
| 1               | 0    | 0    | 8 dB           |
| 1               | 0    | 1    | 10 dB          |
| 1               | 1    | 0    | 12 dB          |
| 1               | 1    | 1    | 14 dB          |

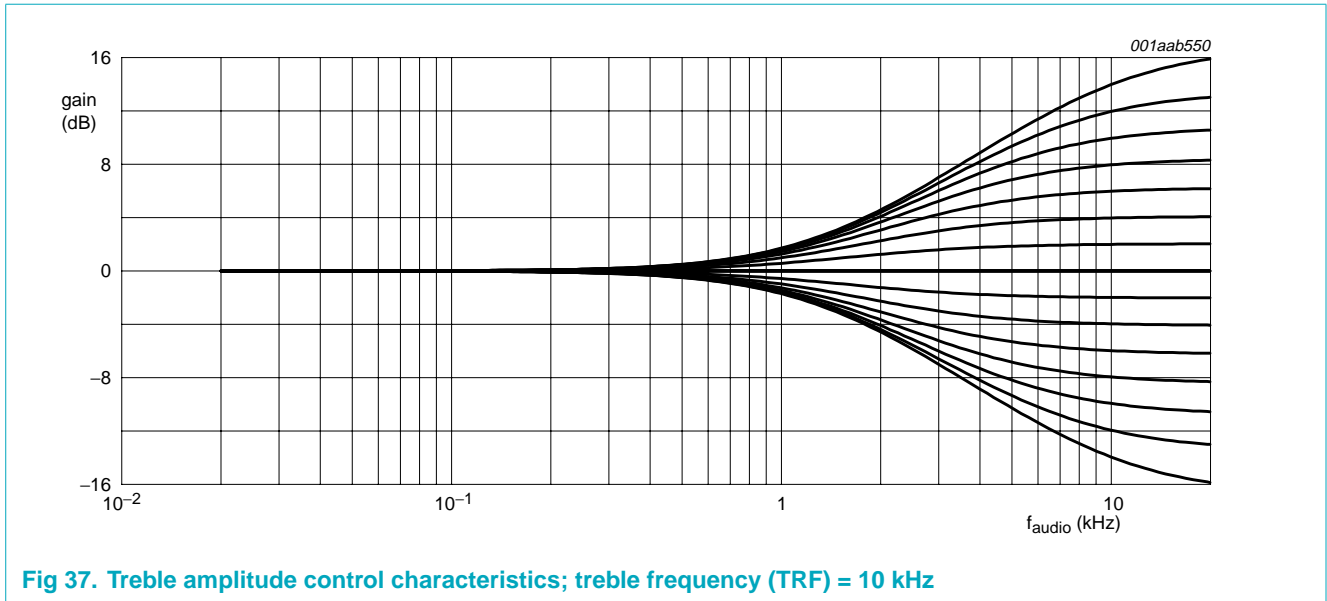

Fig 37. Treble amplitude control characteristics; treble frequency (TRF) = 10 kHz

8.2.21 Write mode: data byte BASS

Table 87. BASS - format of data byte 13h with default setting

| 7    | 6    | 5    | 4    | 3    | 2    | 1    | 0 |
|------|------|------|------|------|------|------|---|
| BAS3 | BAS2 | BAS1 | BAS0 | BASM | BAF1 | BAF0 | 0 |
| 0    | 0    | 0    | 0    | 1    | 1    | 0    |   |

Table 88. BASS - data byte 13h bit description

| Bit     | Symbol   | Description   |
|---------|----------|---|
| 7 to 4  | BAS[3:0] | bass setting; bass amplification or gain setting; see <a href="#">Table 89</a> and <a href="#">Figure 38</a>  |
| 3       | BASM     | bass control mode; bass control of attenuation or gain; see <a href="#">Table 89</a><br>0 = bass mode is set to attenuation<br>1 = bass mode is set to gain |
| 2 and 1 | BAF[1:0] | bass frequency<br>00 = 60 Hz<br>01 = 80 Hz<br>10 = 100 Hz<br>11 = 120 Hz  |
| 0       | -        | reserved; 0 = normal operation  |

Table 89. Bass control setting

| BAS3            | BAS2 | BAS1 | BAS0 | Bass control |
|-----------------|------|------|------|--------------|
| <b>BASM = 0</b> |      |      |      |              |
| 0               | 0    | 0    | 0    | 0 dB         |
| 0               | 0    | 0    | 1    | -2 dB        |
| 0               | 0    | 1    | 0    | -4 dB        |
| 0               | 0    | 1    | 1    | -6 dB        |
| 0               | 1    | 0    | 0    | -8 dB        |
| 0               | 1    | 0    | 1    | -10 dB       |
| 0               | 1    | 1    | 0    | -12 dB       |
| 0               | 1    | 1    | 1    | -14 dB       |
| 1               | 0    | 0    | 1    | -16 dB       |
| 1               | 0    | 1    | 0    | -18 dB       |
| 1               | 0    | 1    | 1    | -20 dB       |
| <b>BASM = 1</b> |      |      |      |              |
| 0               | 0    | 0    | 0    | 0 dB         |
| 0               | 0    | 0    | 1    | 2 dB         |
| 0               | 0    | 1    | 0    | 4 dB         |
| 0               | 0    | 1    | 1    | 6 dB         |
| 0               | 1    | 0    | 0    | 8 dB         |
| 0               | 1    | 0    | 1    | 10 dB        |
| 0               | 1    | 1    | 0    | 12 dB        |
| 0               | 1    | 1    | 1    | 14 dB        |
| 1               | 0    | 0    | 1    | 16 dB        |
| 1               | 0    | 1    | 0    | 18 dB        |
| 1               | 0    | 1    | 1    | 20 dB        |

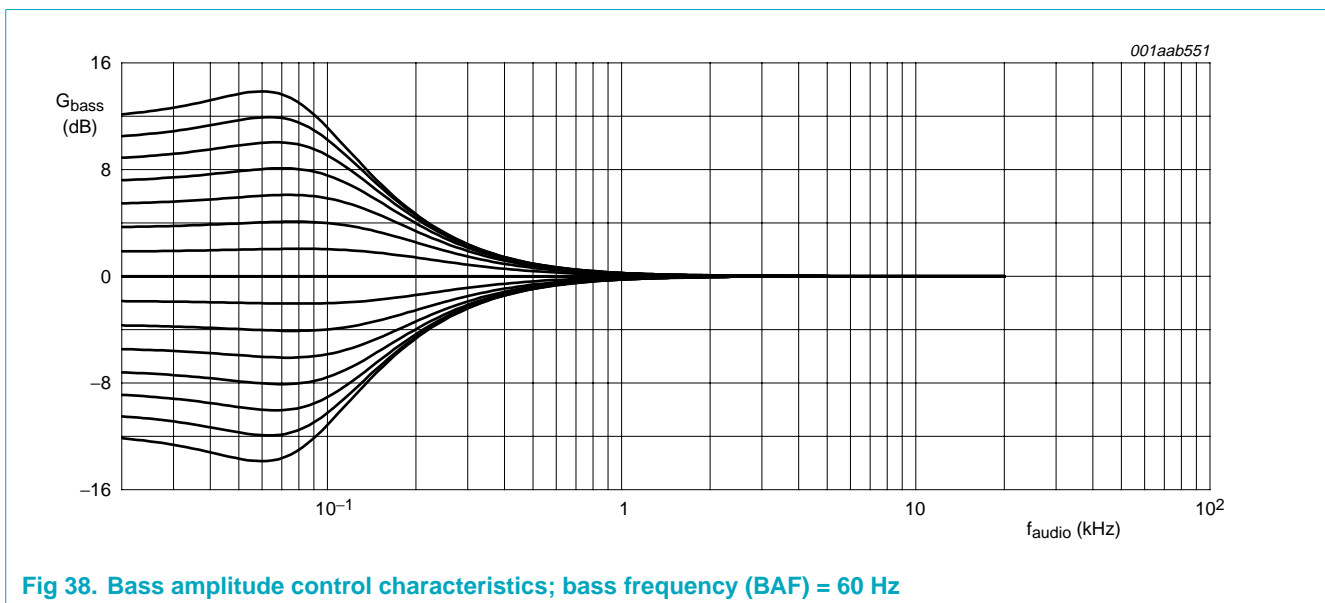

Fig 38. Bass amplitude control characteristics; bass frequency (BAF) = 60 Hz

### 8.2.22 Write mode: data byte FADER

Table 90. FADER - format of data byte 14h with default setting

| 7     | 6     | 5    | 4    | 3    | 2    | 1    | 0    |
|-------|-------|------|------|------|------|------|------|
| FADM1 | FADM0 | FAD5 | FAD4 | FAD3 | FAD2 | FAD1 | FAD0 |
| 0     | 0     | 0    | 0    | 0    | 0    | 0    | 0    |

Table 91. FADER - data byte 14h bit description

| Bit     | Symbol    | Description  |
|---------|-----------|--|
| 7 and 6 | FADM[1:0] | fader mode; enable fader control for front or rear<br>00 = no fader; front output = 0 dB; rear output = 0 dB<br>01 = rear fader; front output = 0 dB; rear output = FAD[5:0]<br>10 = front fader; front output = FAD[5:0]; rear output = 0 dB<br>11 = output volume; front output = FAD[5:0]; rear output = FAD[5:0] |
| 5 to 0  | FAD[5:0]  | Fader attenuation setting; 00 0000 to 11 1111 = -1 dB to -64 dB. For output mute control see data byte 15h; OUTPUT (see <a href="#">Table 92</a> ).  |

### 8.2.23 Write mode: data byte OUTPUT

Table 92. OUTPUT - format of data byte 15h with default setting

| 7 | 6 | 5 | 4    | 3    | 2    | 1    | 0    |
|---|---|---|------|------|------|------|------|
| 0 | 0 | 0 | OUTA | MULF | MURF | MULR | MURR |
|   |   |   | 0    | 1    | 1    | 1    | 1    |

Table 93. OUTPUT - data byte 15h bit description

| Bit    | Symbol | Description   |
|--------|--------|---|
| 7 to 5 | -      | reserved; 0 = normal operation  |
| 4      | OUTA   | output gain<br>0 = standard output gain<br>1 = output gain is 3 dB                  |
| 3      | MULF   | left front output mute<br>0 = output LFOUT is enabled<br>1 = output LFOUT is muted  |
| 2      | MURF   | right front output mute<br>0 = output RFOUT is enabled<br>1 = output RFOUT is muted |
| 1      | MULR   | left rear output mute<br>0 = output LROUT is enabled<br>1 = output LROUT is muted   |
| 0      | MURR   | right rear output mute<br>0 = output RROUT is enabled<br>1 = output RROUT is muted  |

**8.2.24 Write mode: data byte BALANCE**

**Table 94. BALANCE - format of data byte 16h with default setting**

| 7    | 6    | 5    | 4    | 3    | 2    | 1    | 0    |
|------|------|------|------|------|------|------|------|
| BALM | BAL6 | BAL5 | BAL4 | BAL3 | BAL2 | BAL1 | BAL0 |
| 1    | 0    | 0    | 0    | 0    | 0    | 0    | 0    |

**Table 95. BALANCE - data byte 16h bit description**

| Bit    | Symbol   | Description   |
|--------|----------|---|
| 7      | BALM     | balance control mode; sets the balance mode to left or right attenuation<br>0 = left channel is attenuated<br>1 = right channel is attenuated |
| 6 to 0 | BAL[6:0] | balance setting; see <a href="#">Table 96</a>   |

**Table 96. Balance attenuation setting<sup>[1]</sup>**

| BAL6 | BAL5 | BAL4 | BAL3 | BAL2 | BAL1 | BAL0 | Balance (dB) |
|------|------|------|------|------|------|------|--------------|
| 0    | 0    | 0    | 0    | 0    | 0    | 0    | 0            |
| 0    | 0    | 0    | 0    | 0    | 0    | 1    | -1           |
| :    | :    | :    | :    | :    | :    | :    | :            |
| 1    | 1    | 0    | 1    | 1    | 1    | 0    | -110         |
| 1    | 1    | 0    | 1    | 1    | 1    | 1    | -111         |
| 1    | 1    | 1    | 0    | 0    | 0    | 0    | mute         |

[1] The maximum obtainable attenuation of volume and balance is limited to -83 dB. For VOL + BAL attenuation settings below -83 dB; mute is activated.

**8.2.25 Write mode: data byte LOUDNESS**

**Table 97. LOUDNESS - format of data byte 17h with default setting**

| 7    | 6 | 5 | 4    | 3    | 2    | 1    | 0    |
|------|---|---|------|------|------|------|------|
| AVUM | 0 | 0 | LDON | LDHB | LDS2 | LDS1 | LDS0 |
| 0    |   |   | 0    | 1    | 1    | 0    | 0    |

**Table 98. LOUDNESS - data byte 17h bit description**

| Bit     | Symbol | Description  |
|---------|--------|--|
| 7       | AVUM   | audio VU-meter mode <sup>[1]</sup><br>0 = MOD read information indicates the modulation of the radio channel<br>1 and an external input source is selected = MOD read information will indicate the input amplitude of the selected source |
| 6 and 5 | -      | reserved; 0 = normal operation   |
| 4       | LDON   | loudness on<br>0 = loudness control is disabled<br>1 = loudness control is active; loudness is controlled by the volume setting  |

**Table 98. LOUDNESS - data byte 17h bit description ...continued**

| Bit    | Symbol   | Description  |
|--------|----------|--|
| 3      | LDHB     | loudness high boost; see <a href="#">Figure 39</a><br>0 = loudness control is limited to bass gain<br>1 = loudness controls bass gain and treble gain                    |
| 2 to 0 | LDS[2:0] | loudness start setting; loudness start defines the volume setting below which loudness control is activated; see <a href="#">Table 100</a> and <a href="#">Figure 39</a> |

[1] The VU-meter mode can be used with external sources only. When the VU-meter mode is active, the radio quality detection of USN, MOD and OFFS is limited to AF update tuning only. During VU-meter mode the bits MOD[4:0] indicate the external source input amplitude. The FM dynamic bandwidth control is disabled and a fixed bandwidth of 113 kHz is defined. However, other fixed bandwidth settings are available by DYN = 0 and the setting of BW; data byte 0h (see [Table 28](#)). See [Table 99](#) for compression recovery timing control. VU-meter mode is automatically activated when audio compression is on (COMP = 1).

**Table 99. VU-meter timing; HTC[2:0] of data byte 0Bh; TIMING<sup>[1]</sup>**

| HTC2 | HTC1 | HTC0 | t <sub>attack</sub> | t <sub>recovery</sub> |
|------|------|------|---------------------|-----------------------|
| 0    | 0    | 0    | 0.02 s              | 0.03 s                |
| 0    | 0    | 1    | 0.02 s              | 0.06 s                |
| 0    | 1    | 0    | 0.02 s              | 0.2 s                 |
| 0    | 1    | 1    | 0.02 s              | 5 s                   |
| 1    | 0    | 0    | 0.02 s              | 0.6 s                 |
| 1    | 0    | 1    | 0.02 s              | 10 s                  |
| 1    | 1    | 0    | 0.02 s              | 1 s                   |
| 1    | 1    | 1    | 0.02 s              | 2 s                   |

[1] Setting HTC[2:0] is also in use for setting the timing of weak signal high cut control during radio operation.

**Table 100. Loudness start**

| LDS2 | LDS1 | LDS0 | Start of loudness at volume setting |
|------|------|------|-------------------------------------|
| 0    | 0    | 0    | -12 dB                              |
| 0    | 0    | 1    | -16 dB                              |
| 0    | 1    | 0    | -20 dB                              |
| 0    | 1    | 1    | -24 dB                              |
| 1    | 0    | 0    | -28 dB                              |
| 1    | 0    | 1    | -32 dB                              |
| 1    | 1    | 0    | -36 dB                              |
| 1    | 1    | 1    | -40 dB                              |

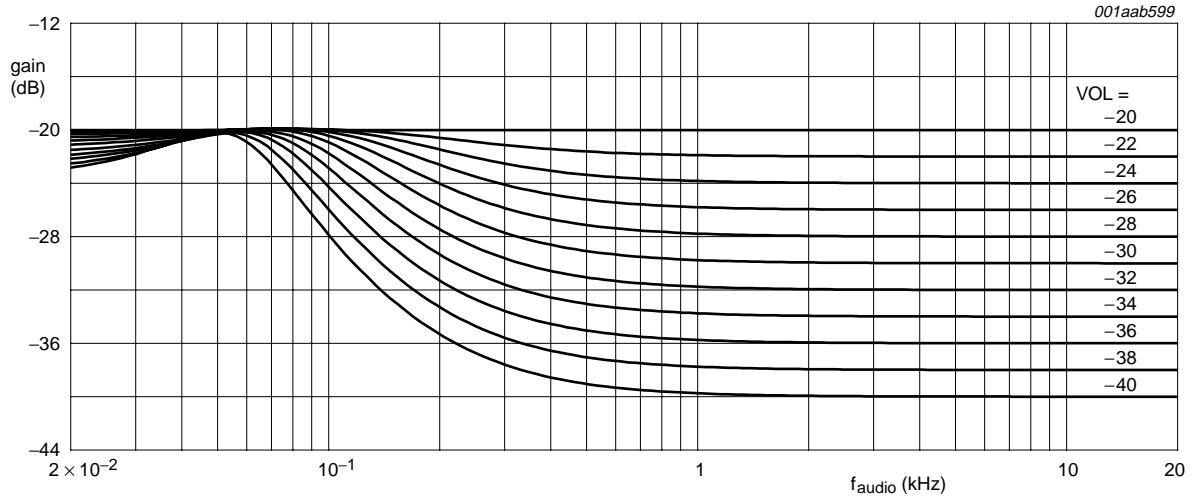

a. LDON = 1, LDHB = 0.

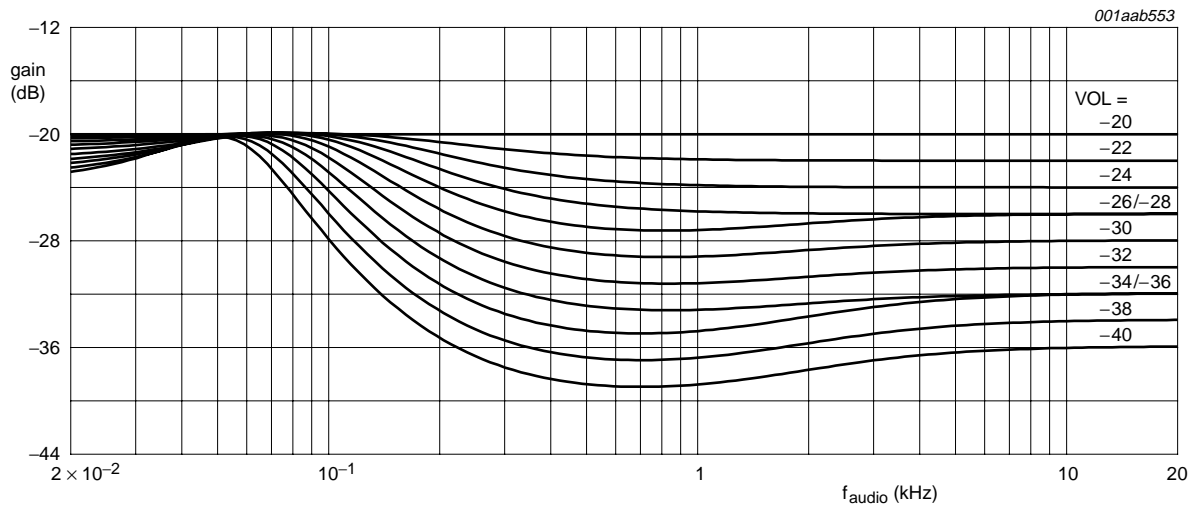

b. LDON = 1, LDHB = 1.

**Fig 39. Loudness control characteristics; loudness start = -20 dB, bass frequency = 60 Hz, treble frequency = 10 kHz; bass gain = 0 dB, treble gain = 0 dB**

**8.2.26 Write mode: data byte POWER**

**Table 101. POWER - format of data byte 18h with default setting**

| 7 | 6    | 5    | 4 | 3 | 2   | 1    | 0    |
|---|------|------|---|---|-----|------|------|
| 0 | STBT | STBR | 0 | 0 | ASI | AST1 | AST0 |
|   | 0    | 0    |   |   | 1   | 1    | 0    |

**Table 102. POWER - data byte 18h bit description<sup>[1]</sup>**

| Bit     | Symbol   | Description   |
|---------|----------|---|
| 7       | -        | reserved; 0 = normal operation  |
| 6       | STBT     | standby tuner<br>0 = normal operation<br>1 = power consumption is reduced by disabling part of the tuner circuit; radio operation is disabled |
| 5       | STBR     | standby RDS demodulator<br>0 = normal operation<br>1 = RDS demodulator in Standby mode  |
| 4 and 3 | -        | reserved; 0 = normal operation  |
| 2       | ASI      | audio step interpolation<br>0 = audio step interpolation is disabled<br>1 = audio step interpolation is enabled                               |
| 1 and 0 | AST[1:0] | ASI step time; selection of the audio step interpolation time<br>00 = 1 ms<br>01 = 3 ms<br>10 = 10 ms<br>11 = 30 ms                           |

[1] The power saving offered by the Standby modes is limited and is not intended to realize an effective power-down.

**8.2.27 Write mode: data bytes RESERVED**

**Table 103. RESERVED - format of data byte 19h to 1Eh**

| 7 | 6 | 5 | 4 | 3 | 2 | 1 | 0 |
|---|---|---|---|---|---|---|---|
| 0 | 0 | 0 | 0 | 0 | 0 | 0 | 0 |

**Table 104. RESERVED - data byte 19h to 1Eh bit description<sup>[1]</sup>**

| Bit    | Symbol | Description                    |
|--------|--------|--------------------------------|
| 7 to 0 | -      | reserved; 0 = normal operation |

[1] Reserved bits may control test options for factory testing.



8.2.28 Write mode: data byte TEST

Table 105. TEST - format of data byte 1Fh

| 7    | 6 | 5     | 4     | 3     | 2     | 1     | 0     |
|------|---|-------|-------|-------|-------|-------|-------|
| RBWR | 0 | TEST5 | TEST4 | TEST3 | TEST2 | TEST1 | TEST0 |
| 0    |   | 0     | 0     | 0     | 0     | 0     | 0     |

Table 106. TEST - data byte 1Fh bit description

| Bit    | Symbol    | Description   |
|--------|-----------|---|
| 7      | RBWR      | next I <sup>2</sup> C-bus read contains write register data (RBWR will be reset to logic 0 after read)  |
| 6      | -         | reserved; 0 = normal operation  |
| 5 to 0 | TEST[5:0] | test mode<br>00 0000 = normal operation<br>00 1011 = AM IF noise blanker disabled<br>00 1110 = AM IF noise blanker and AM audio noise blanker disabled<br>01 1001 = AM audio noise blanker and FM noise blanker disabled<br>all other settings are reserved |

9. Limiting values

Table 107. Limiting values

In accordance with the Absolute Maximum Rating System (IEC 60134).

| Symbol           | Parameter   | Conditions       | Min       | Max                   | Unit |
|------------------|---|------------------|-----------|-----------------------|------|
| V <sub>CC</sub>  | analog supply voltage on pins VCC, VCCPLL, VCCVCO, VCCRF, AMMIX2OUT1, AMMIX2OUT2, MIX1OUT1 and MIX1OUT2 |                  | -0.3      | +10                   | V    |
| ΔV <sub>CC</sub> | voltage difference between any VCC pins   |                  | -0.3      | +0.3                  | V    |
| V <sub>V60</sub> | supply voltage for FM filter and demodulator  |                  | [1] -0.3  | V <sub>CC</sub> + 0.3 | V    |
| V <sub>I</sub>   | digital input voltage on pins SCL, SDA and ADDR   |                  | -0.3      | +5.5                  | V    |
| V <sub>n</sub>   | voltage on all other pins   |                  | [1] -0.3  | V <sub>CC</sub> + 0.3 | V    |
| T <sub>stg</sub> | storage temperature   |                  | -40       | +150                  | °C   |
| T <sub>j</sub>   | junction temperature  |                  | -         | 150                   | °C   |
| T <sub>amb</sub> | ambient temperature   |                  | -40       | +85                   | °C   |
| V <sub>esd</sub> | electrostatic discharge voltage on  |                  |           |                       |      |
|                  | all pins except VCCVCO  | human body model | [2] -2000 | +2000                 | V    |
|                  |   | machine model    | [3] -200  | +200                  | V    |
|                  | pin VCCVCO  | human body model | [4] -1750 | +1750                 | V    |
|                  |   | machine model    | [5] -175  | +175                  | V    |

- [1] The maximum voltage should be less than 10 V.
- [2] Class 2 according to JESD22-A114C.01.
- [3] Class B according to EIA/JESD22-A115-A.
- [4] Class 1C according to JESD22-A114C.01.
- [5] Class A according to EIA/JESD22-A115-A.

## 10. Thermal characteristics

Table 108. Thermal characteristics

| Symbol        | Parameter                                   | Conditions  | Typ | Unit |
|---------------|---|-------------|-----|------|
| $R_{th(j-a)}$ | thermal resistance from junction to ambient | in free air | 55  | K/W  |
| $R_{th(j-c)}$ | thermal resistance from junction to case    |             | 18  | K/W  |

## 11. Static characteristics

Table 109. Static characteristics

$V_{CC} = 8.5\text{ V}$ ;  $T_{amb} = 25\text{ °C}$ ; unless otherwise specified.

| Symbol                            | Parameter   | Conditions                | Min  | Typ  | Max  | Unit |
|-----------------------------------|---|---------------------------|------|------|------|------|
| <b>Supply voltage</b>             |   |                           |      |      |      |      |
| $V_{CC}$                          | analog supply voltage on pins VCC, VCCPLL, VCCVCO, VCCRF, AMMIX2OUT1, AMMIX2OUT2, MIX1OUT1 and MIX1OUT2 |                           | 8    | 8.5  | 9    | V    |
| $V_{V60}$                         | supply voltage for FM filter and demodulator  |                           | 5.5  | 7.2  | -    | V    |
| <b>Current in FM mode</b>         |   |                           |      |      |      |      |
| $I_{CC}$                          | supply current  | $T_{amb} = -40\text{ °C}$ | -    | 49   | -    | mA   |
|                                   |   | $T_{amb} = 25\text{ °C}$  | 40   | 49   | 60   | mA   |
|                                   |   | $T_{amb} = 85\text{ °C}$  | -    | 49   | -    | mA   |
| $I_{CCPLL}$                       | supply current for tuning PLL   | $T_{amb} = -40\text{ °C}$ | -    | 4.0  | -    | mA   |
|                                   |   | $T_{amb} = 25\text{ °C}$  | 2.9  | 3.6  | 5    | mA   |
|                                   |   | $T_{amb} = 85\text{ °C}$  | -    | 3.3  | -    | mA   |
| $I_{CCVCO}$                       | supply current for VCO  | $T_{amb} = -40\text{ °C}$ | -    | 2.2  | -    | mA   |
|                                   |   | $T_{amb} = 25\text{ °C}$  | -    | 2.1  | -    | mA   |
|                                   |   | $T_{amb} = 85\text{ °C}$  | -    | 2.0  | -    | mA   |
| $I_{CCRF}$                        | supply current for RF   | $T_{amb} = -40\text{ °C}$ | -    | 12   | 16   | mA   |
|                                   |   | $T_{amb} = 25\text{ °C}$  | 10.5 | 13.5 | 16.5 | mA   |
|                                   |   | $T_{amb} = 85\text{ °C}$  | -    | 14   | 18.5 | mA   |
| $I_{V60}$                         | supply current for FM filter and demodulator  | $T_{amb} = -40\text{ °C}$ | -    | 28   | -    | mA   |
|                                   |   | $T_{amb} = 25\text{ °C}$  | 22   | 28   | 34   | mA   |
|                                   |   | $T_{amb} = 85\text{ °C}$  | -    | 28   | -    | mA   |
| $I_{MIX1OUT1};$<br>$I_{MIX1OUT2}$ | bias current of FM and AM mixer 1 at output 1 or output 2   | $T_{amb} = -40\text{ °C}$ | -    | 5.3  | -    | mA   |
|                                   |   | $T_{amb} = 25\text{ °C}$  | 4.3  | 5.7  | 7.5  | mA   |
|                                   |   | $T_{amb} = 85\text{ °C}$  | -    | 6.0  | 8.0  | mA   |
| <b>Current in AM mode</b>         |   |                           |      |      |      |      |
| $I_{CC}$                          | supply current  | $T_{amb} = -40\text{ °C}$ | -    | 58   | -    | mA   |
|                                   |   | $T_{amb} = 25\text{ °C}$  | 44   | 58   | 75   | mA   |
|                                   |   | $T_{amb} = 85\text{ °C}$  | -    | 58   | -    | mA   |

Table 109. Static characteristics ...continued

 $V_{CC} = 8.5\text{ V}$ ;  $T_{amb} = 25\text{ °C}$ ; unless otherwise specified.

| Symbol                                 | Parameter   | Conditions                | Min | Typ  | Max  | Unit |
|--|---|---------------------------|-----|------|------|------|
| $I_{CCPLL}$                            | supply current for tuning PLL                             | $T_{amb} = -40\text{ °C}$ | -   | 3.9  | -    | mA   |
|  |   | $T_{amb} = 25\text{ °C}$  | 2.9 | 3.6  | 5    | mA   |
|  |   | $T_{amb} = 85\text{ °C}$  | -   | 3.2  | -    | mA   |
| $I_{CCVCO}$                            | supply current for VCO                                    | $T_{amb} = -40\text{ °C}$ | -   | 2.2  | -    | mA   |
|  |   | $T_{amb} = 25\text{ °C}$  | -   | 2.1  | -    | mA   |
|  |   | $T_{amb} = 85\text{ °C}$  | -   | 2.0  | -    | mA   |
| $I_{CCRF}$                             | supply current for RF                                     | $T_{amb} = -40\text{ °C}$ | -   | 8.8  | -    | mA   |
|  |   | $T_{amb} = 25\text{ °C}$  | 6.7 | 8.8  | 13   | mA   |
|  |   | $T_{amb} = 85\text{ °C}$  | -   | 8.8  | -    | mA   |
| $I_{V60}$                              | supply current for FM filter and demodulator              | $T_{amb} = -40\text{ °C}$ | -   | 8.0  | -    | mA   |
|  |   | $T_{amb} = 25\text{ °C}$  | 6   | 7.8  | 10.2 | mA   |
|  |   | $T_{amb} = 85\text{ °C}$  | -   | 7.5  | -    | mA   |
| $I_{MIX1OUT1}$ ;<br>$I_{MIX1OUT2}$     | bias current of FM and AM mixer 1 at output 1 or output 2 | $T_{amb} = -40\text{ °C}$ | -   | 3.6  | -    | mA   |
|  |   | $T_{amb} = 25\text{ °C}$  | 2.6 | 3.45 | 4.5  | mA   |
|  |   | $T_{amb} = 85\text{ °C}$  | -   | 3.3  | -    | mA   |
| $I_{AMMIX2OUT1}$ ;<br>$I_{AMMIX2OUT2}$ | bias current of AM mixer 2 at output 1 or output 2        | $T_{amb} = -40\text{ °C}$ | -   | 5.5  | -    | mA   |
|  |   | $T_{amb} = 25\text{ °C}$  | 3.7 | 4.6  | 5.5  | mA   |
|  |   | $T_{amb} = 85\text{ °C}$  | -   | 3.7  | -    | mA   |

**Logic pins**

|                |   |   |      |   |      |               |
|----------------|---|---|------|---|------|---------------|
| $V_{IH}$       | HIGH-level input voltage (pins RDCL and ADDR)   |   | 1.75 | - | 5.5  | V             |
| $V_{IL}$       | LOW-level input voltage (pins RDCL and ADDR)    |   | -0.2 | - | +1.0 | V             |
| $I_{leak(od)}$ | open-drain leakage current (pins RDCL and RDDA) |   | -10  | - | +10  | $\mu\text{A}$ |
| $V_{OL}$       | LOW-level output voltage (pins RDCL and RDDA)   | open collector;<br>$I_{OL} = 3\text{ mA}$ | -    | - | 0.4  | V             |

**Power-on reset; all registers in default setting, outputs muted, Standby mode**

|               |  |                                |      |     |      |   |
|---------------|--|--------------------------------|------|-----|------|---|
| $V_{th(POR)}$ | threshold value of $V_{CC}$ for power-on reset | $V_{CC}$ drop during operation |      |     |      |   |
|               |  | $T_{amb} = -40\text{ °C}$      | -    | 6.8 | -    | V |
|               |  | $T_{amb} = 25\text{ °C}$       | 6.15 | 6.3 | 6.45 | V |
|               |  | $T_{amb} = 85\text{ °C}$       | -    | 5.8 | -    | V |

## 12. Dynamic characteristics

### 12.1 Dynamic characteristics of the tuner

**Table 110. Dynamic characteristics of the tuner**

$V_{CC} = 8.5\text{ V}$ ;  $T_{amb} = 25\text{ °C}$ ; see [Figure 43](#); all AC values are given in RMS; unless otherwise specified.

| Symbol  | Parameter  | Conditions  | Min    | Typ   | Max   | Unit                                  |
|---|--|---|--------|-------|-------|---------------------------------------|
| <b>Crystal oscillator</b>   |  |   |        |       |       |                                       |
| $f_{xtal}$  | crystal frequency  |   | -      | 20.5  | -     | MHz                                   |
| C/N   | carrier-to-noise ratio                                       | $f_{xtal} = 20.5\text{ MHz}$ ; $\Delta f = 10\text{ kHz}$   | 112    | -     | -     | $\frac{\text{dBc}}{\sqrt{\text{Hz}}}$ |
| <b>Circuit inputs: pins XTAL1 and XTAL2</b>   |  |   |        |       |       |                                       |
| $V_{o(osc)(rms)}$   | oscillator output voltage (RMS value)                        |   | [1] 80 | 100   | 160   | mV                                    |
| $R_i$   | real part of input impedance                                 | $V_{XTAL1-XTAL2} = 1\text{ mV}$   | [1] -  | -500  | -250  | $\Omega$                              |
| $C_i$   | input capacitance  |   | [1] -  | 8     | -     | pF                                    |
| <b>Tuning system; see <a href="#">Table 38</a>, <a href="#">Table 39</a> and <a href="#">Table 41</a></b> |  |   |        |       |       |                                       |
| <b>Voltage controlled oscillator</b>  |  |   |        |       |       |                                       |
| $f_{osc(min)}$  | minimum oscillator frequency                                 |   | -      | -     | 153.6 | MHz                                   |
| $f_{osc(max)}$  | maximum oscillator frequency                                 |   | 256    | -     | -     | MHz                                   |
| C/N   | carrier-to-noise ratio                                       | $f_{osc} = 200\text{ MHz}$ ; $\Delta f = 10\text{ kHz}$ ; $Q \geq 30$   | -      | 98    | -     | $\frac{\text{dBc}}{\sqrt{\text{Hz}}}$ |
| RR  | ripple rejection;<br>$RR = \frac{V_{CC(ripple)}}{V_{MPXAM}}$ | $f_{ripple} = 100\text{ Hz}$ ;<br>$V_{CC(ripple)} = 50\text{ mV (RMS)}$ ;<br>$f_{osc} = 200\text{ MHz}$ ; FM mode | 44     | 50    | -     | dB                                    |
| <b>Charge pump: pin CPOUT; see <a href="#">Table 40</a></b>   |  |   |        |       |       |                                       |
| $I_{sink(CP1)}$   | charge pump CP1 sink current                                 | $V_{CPOUT} = 0.5\text{ V}$ to $V_{CCPLL} - 1.3\text{ V}$ ; $f_{ref} = 100\text{ kHz}$                             | 130    | 180   | 240   | $\mu\text{A}$                         |
| $I_{source(CP1)}$   | charge pump CP1 source current                               | $V_{CPOUT} = 0.5\text{ V}$ to $V_{CCPLL} - 1.3\text{ V}$ ; $f_{ref} = 100\text{ kHz}$                             | -240   | -180  | -130  | $\mu\text{A}$                         |
| $I_{sink(CP2)}$   | charge pump CP2 sink current                                 | $V_{CPOUT} = 0.7\text{ V}$ to $V_{CCPLL} - 1.5\text{ V}$ ; $f_{ref} = 50\text{ kHz}$                              | 270    | 360   | 480   | $\mu\text{A}$                         |
| $I_{source(CP2)}$   | charge pump CP2 source current                               | $V_{CPOUT} = 0.7\text{ V}$ to $V_{CCPLL} - 1.5\text{ V}$ ; $f_{ref} = 50\text{ kHz}$                              | -480   | -360  | -270  | $\mu\text{A}$                         |
| $I_{sink(CP3)}$   | charge pump CP3 sink current                                 | $V_{CPOUT} = 0.7\text{ V}$ to $V_{CCPLL} - 0.7\text{ V}$ ;<br>$f_{ref} = 20\text{ kHz}$ or $25\text{ kHz}$        | 580    | 780   | 1050  | $\mu\text{A}$                         |
| $I_{source(CP3)}$   | charge pump CP3 source current                               | $V_{CPOUT} = 0.7\text{ V}$ to $V_{CCPLL} - 0.7\text{ V}$ ;<br>$f_{ref} = 20\text{ kHz}$ or $25\text{ kHz}$        | -1050  | -780  | -580  | $\mu\text{A}$                         |
| $I_{sink(CP4)}$   | charge pump CP4 sink current                                 | $V_{CPOUT} = 0.7\text{ V}$ to $V_{CCPLL} - 0.7\text{ V}$ ; $f_{ref} = 20\text{ kHz}$                              | 1040   | 1400  | 1900  | $\mu\text{A}$                         |
| $I_{source(CP4)}$   | charge pump CP4 source current                               | $V_{CPOUT} = 0.7\text{ V}$ to $V_{CCPLL} - 0.7\text{ V}$ ; $f_{ref} = 20\text{ kHz}$                              | -1900  | -1400 | -1040 | $\mu\text{A}$                         |

Table 110. Dynamic characteristics of the tuner ...continued

 $V_{CC} = 8.5\text{ V}$ ;  $T_{amb} = 25\text{ °C}$ ; see Figure 43; all AC values are given in RMS; unless otherwise specified.

| Symbol                   | Parameter                      | Conditions  | Min   | Typ   | Max   | Unit          |
|--------------------------|--------------------------------|---|-------|-------|-------|---------------|
| $I_{\text{sink(}CP5)}$   | charge pump CP5 sink current   | $V_{\text{CPOUT}} = 0.7\text{ V}$ to $V_{\text{CCPLL}} - 0.7\text{ V}$ ; $f_{\text{ref}} = 10\text{ kHz}$ | 1630  | 2200  | 2970  | $\mu\text{A}$ |
| $I_{\text{source(}CP5)}$ | charge pump CP5 source current | $V_{\text{CPOUT}} = 0.7\text{ V}$ to $V_{\text{CCPLL}} - 0.7\text{ V}$ ; $f_{\text{ref}} = 10\text{ kHz}$ | -2970 | -2200 | -1630 | $\mu\text{A}$ |

## Charge pump: pin VTUNE

|                     |   |  |       |       |       |               |
|---------------------|---|--|-------|-------|-------|---------------|
| $I_{\text{sink}}$   | charge pump sink current  | $V_{\text{VTUNE}} = 0.8\text{ V}$ to $V_{\text{CCPLL}} - 0.7\text{ V}$   | 2070  | 2800  | 3780  | $\mu\text{A}$ |
| $I_{\text{source}}$ | charge pump source current  | $V_{\text{VTUNE}} = 0.8\text{ V}$ to $V_{\text{CCPLL}} - 0.7\text{ V}$   | -3780 | -2800 | -2070 | $\mu\text{A}$ |
| $t_{\text{tune}}$   | tuning time   | Europe FM and US FM band;<br>$f_{\text{ref}} = 100\text{ kHz}$ ; $f_{\text{RF}} = 87.5\text{ MHz}$ to $108\text{ MHz}$ | -     | 0.75  | 1     | ms            |
|                     |   | AM MW band; $f_{\text{ref}} = 20\text{ kHz}$ ;<br>$f_{\text{RF}} = 0.53\text{ MHz}$ to $1.7\text{ MHz}$                | -     | 5     | 20    | ms            |
| $T_{\text{cy}}$     | inaudible AF update cycle time including 1 ms mute start and 1 ms mute release time |  | -     | 6     | 6.5   | ms            |

## Antenna Digital Auto Alignment (DAA)

DAA: pin DAAOUT<sup>[2]</sup>

|                               |  |   |                   |    |                   |               |
|-------------------------------|--|---|-------------------|----|-------------------|---------------|
| $I_{\text{leak(DAA)}}$        | antenna DAA input leakage current on pin VTUNE (test mode) | $V_{\text{VTUNE}} = 0.4\text{ V}$ to $8\text{ V}$   | -10               | -  | +10               | nA            |
| $\Delta V_{\text{o(T)}}$      | output voltage variation with temperature                  | $T_{\text{amb}} = -40\text{ °C}$ to $+85\text{ °C}$ ;<br>$\text{DAA}[6:0] = 100\ 0000$    | -30               | -  | +30               | mV            |
| $\Delta V_{\text{o(sink)}}$   | output voltage variation caused by sink current            | $V_{\text{VTUNE}} = 4\text{ V}$ ; $I_{\text{L}} = 50\ \mu\text{A}$                        | $-V_{\text{LSB}}$ | -  | $+V_{\text{LSB}}$ |               |
| $\Delta V_{\text{o(source)}}$ | output voltage variation caused by source current          | $V_{\text{VTUNE}} = 4\text{ V}$ ; $I_{\text{L}} = -50\ \mu\text{A}$                       | $-V_{\text{LSB}}$ | -  | $+V_{\text{LSB}}$ |               |
| $t_{\text{st}}$               | settling time  | $V_{\text{DAAOUT}} = 0.2\text{ V}$ to $8.25\text{ V}$ ;<br>$C_{\text{L}} = 270\text{ pF}$ | -                 | 30 | 60                | $\mu\text{s}$ |

## AM mode

|                |                |                               |     |   |     |   |
|----------------|----------------|-------------------------------|-----|---|-----|---|
| $V_{\text{o}}$ | output voltage | $\text{DAA}[6:0] = 000\ 0000$ | -   | - | 0.5 | V |
|                |                | $\text{DAA}[6:0] = 111\ 1111$ | 8.0 | - | 8.5 | V |

## FM mode

|                             |                      |  |                      |    |                      |               |
|-----------------------------|----------------------|--|----------------------|----|----------------------|---------------|
| $V_{\text{o(n)}}$           | output noise voltage | $V_{\text{VTUNE}} = 4\text{ V}$ ;<br>$\text{DAA}[6:0] = 100\ 0000$ ;<br>$B = 300\text{ Hz}$ to $22\text{ kHz}$   | -                    | 30 | 100                  | $\mu\text{V}$ |
| RR                          | ripple rejection     | $V_{\text{VTUNE}} = 4\text{ V}$ ;<br>$\text{DAA}[6:0] = 101\ 0101$ ;<br>$f_{\text{ripple}} = 100\text{ Hz}$ ;<br>$V_{\text{CC(ripple)}} = 100\text{ mV}$ | -                    | 40 | -                    | dB            |
| $\Delta V_{\text{o(step)}}$ | step accuracy        | $V_{\text{VTUNE}} = 2\text{ V}$  | $-0.5V_{\text{LSB}}$ | 0  | $+0.5V_{\text{LSB}}$ |               |

Table 110. Dynamic characteristics of the tuner ...continued

 $V_{CC} = 8.5\text{ V}$ ;  $T_{amb} = 25\text{ }^{\circ}\text{C}$ ; see [Figure 43](#); all AC values are given in RMS; unless otherwise specified.

| Symbol | Parameter              | Conditions  | Min  | Typ  | Max  | Unit |
|--------|------------------------|---|------|------|------|------|
| $V_o$  | output voltage         | $V_{VTUNE} = 0.5\text{ V}$ ;<br>$DAA[6:0] = 000\ 0000$  | -    | -    | 0.5  | V    |
|        |                        | $V_{VTUNE} = 4.25\text{ V}$ ;<br>$DAA[6:0] = 111\ 1111$ | 8    | -    | -    | V    |
|        |                        | $V_{VTUNE} = 4\text{ V}$                                |      |      |      |      |
|        |                        | $DAA[6:0] = 000\ 0000$                                  | -    | -    | 0.5  | V    |
|        |                        | $DAA[6:0] = 100\ 0000$                                  | 3.8  | 4.23 | 4.65 | V    |
|        |                        | $V_{VTUNE} = 2\text{ V}$                                |      |      |      |      |
|        |                        | $DAA[6:0] = 101\ 0101$                                  | 2.45 | 2.74 | 3.05 | V    |
|        | $DAA[6:0] = 010\ 1010$ | 1.3   | 1.46 | 1.6  | V    |      |

**AM channel**AM RF AGC detector A: pin AMMIX1IN; see [Figure 40](#)

|                     |  |                           |     |      |      |    |
|---------------------|--|---------------------------|-----|------|------|----|
| $V_{AMMIX1IN(p-p)}$ | AM AGC start level<br>(peak-to-peak value) | $AGC[1:0] = 00$ ; $m = 1$ | 700 | 1000 | 1400 | mV |
|---------------------|--|---------------------------|-----|------|------|----|

AM RF AGC detector B: pin AMIF2IN; see [Figure 40](#)

|                    |  |                                     |   |      |   |   |
|--------------------|--|-------------------------------------|---|------|---|---|
| $V_{AMIF2IN(p-p)}$ | IF voltage on pin<br>AMIF2IN for AGC start<br>(peak-to-peak value) | $m = 1$ ; $f_{mod} = 400\text{ Hz}$ | - | 0.23 | - | V |
|--------------------|--|-------------------------------------|---|------|---|---|

**RF cascode AGC**

|                |  |  |     |      |   |               |
|----------------|--|--|-----|------|---|---------------|
| $\Delta AGC$   | AGC control range                        |  | -   | 10   | - | dB            |
| $V_{VAMCAS}$   | cascode base voltage                     | $AGC[1:0] = 00$ ; maximum gain<br>at cascode AGC | -   | 5    | - | V             |
| $R_{VAMCAS}$   | cascode base source<br>resistance        |  | -   | 1.6  | - | k $\Omega$    |
| $I_{VAMCAS}$   | cascode base current<br>drive capability | source current                                   | 100 | -    | - | $\mu\text{A}$ |
|                |  | sink current                                     | -   | 0    | - | $\mu\text{A}$ |
| $V_{VAMCASFB}$ | cascode emitter<br>DC voltage            | minimum gain at cascode<br>AGC                   | -   | 320  | - | mV            |
|                |  | maximum gain at cascode<br>AGC                   |     |      |   |               |
|                |  | $KAGC = 1$                                       | -   | 800  | - | mV            |
|                |  | $KAGC = 0$                                       | -   | 4.15 | - | V             |
| $I_{VAMCASFB}$ | cascode feedback<br>current              |  | -   | -    | 2 | $\mu\text{A}$ |

**RF PIN diode AGC current generator output: pin IAMAGC**

|                 |                                |   |     |      |     |               |
|-----------------|--------------------------------|---|-----|------|-----|---------------|
| $\Delta AGC$    | AGC control range              | $f_{RF} = 999\text{ kHz}$ ; dummy aerial<br>15 pF/60 pF | -   | 50   | -   | dB            |
| $I_{sink(max)}$ | maximum AGC sink<br>current    | $V_{IAMAGC} > 1\text{ V}$                               | 10  | -    | -   | mA            |
| $I_{source}$    | AGC source current             | AGC not active  | -   | -2.5 | -   | $\mu\text{A}$ |
| $I_{sink(FM)}$  | AGC sink current in<br>FM mode | $AGCSW = 1$   | 0.5 | 1    | -   | mA            |
|                 |                                | $AGCSW = 0$   | -   | -    | 100 | nA            |

Table 110. Dynamic characteristics of the tuner ...continued

 $V_{CC} = 8.5\text{ V}$ ;  $T_{amb} = 25\text{ °C}$ ; see Figure 43; all AC values are given in RMS; unless otherwise specified.

| Symbol          | Parameter                                   | Conditions     | Min | Typ | Max | Unit          |
|-----------------|---|----------------|-----|-----|-----|---------------|
| $C_{IAMAGC}$    | source current generator output capacitance |                | -   | 3   | -   | pF            |
| $V_{VDCPIN}$    | bias voltage for AM PIN diode               |                | 4.5 | 5   | 5.5 | V             |
| $R_{VDCPIN}$    | bias source resistance                      |                | -   | 150 | -   | $\Omega$      |
| $I_{bias(max)}$ | maximum bias current                        | source current | 20  | -   | -   | mA            |
|                 |   | sink current   | 30  | -   | -   | $\mu\text{A}$ |

## AM mixer 1 (IF1 = 10.7 MHz)

Mixer input: pins AMMIX1IN and AMMIX1DEC

|              |                       |   |        |      |    |            |
|--------------|-----------------------|---|--------|------|----|------------|
| $R_i$        | input resistance      |   | [3] 10 | 13.2 | 16 | k $\Omega$ |
| $C_i$        | input capacitance     |   | [3] -  | 3    | -  | pF         |
| $V_{i(max)}$ | maximum input voltage | 1 dB compression point of $V_{MIX1OUT1-MIX1OUT2}$ ; $m = 0$ | 500    | -    | -  | mV         |

Mixer output: pins MIX1OUT1 and MIX1OUT2

|                   |  |   |         |      |      |                                      |
|-------------------|--|---|---------|------|------|--------------------------------------|
| $V_{o(max)(p-p)}$ | maximum output voltage (peak-to-peak value)  |   | -       | 12   | -    | V                                    |
| $g_{m(conv)}$     | conversion transconductance $I_o/V_i$  |   | 1.75    | 2.5  | 3.25 | $\frac{\text{mA}}{\text{V}}$         |
| $g_{m(conv)(T)}$  | conversion transconductance variation with temperature related to $T_{amb} = 25\text{ °C}$ | $T_{amb} = -40\text{ °C}$   | -       | 1    | -    | dB                                   |
|                   |  | $T_{amb} = 85\text{ °C}$  | -       | -0.2 | -    | dB                                   |
| $R_o$             | output resistance  |   | [4] 100 | -    | -    | k $\Omega$                           |
| $C_o$             | output capacitance   |   | [4] -   | 4    | 7    | pF                                   |
| IP3               | 3rd-order intercept point  | $R_L = 2.6\text{ k}\Omega$ (AC load between output pins); $\Delta f = 300\text{ kHz}$   | 135     | 138  | -    | dB $\mu\text{V}$                     |
| IP2               | 2nd-order intercept point  | $R_L = 2.6\text{ k}\Omega$ (AC load between output pins)  | -       | 170  | -    | dB $\mu\text{V}$                     |
| $V_{i(n)(eq)}$    | equivalent input noise voltage   | band limited noise; $R_{gen} = 750\text{ }\Omega$ ; noise of $R_{gen}$ included; $R_L = 2.6\text{ k}\Omega$ (AC load between output pins) | -       | 5.8  | 8    | $\frac{\text{nV}}{\sqrt{\text{Hz}}}$ |
| F                 | noise figure of AM mixer 1   |   | -       | 4.5  | 7.1  | dB                                   |

## AM mixer 2 (IF2 = 450 kHz)

Mixer input: pins IF1IN and IF1DEC

|                 |                                    |   |       |     |   |          |
|-----------------|------------------------------------|---|-------|-----|---|----------|
| $R_i$           | input resistance                   |   | [5] - | 330 | - | $\Omega$ |
| $C_i$           | input capacitance                  |   | [5] - | 3   | - | pF       |
| $V_{i(max)(p)}$ | maximum input voltage (peak value) | 1 dB compression point of $V_{AMMIX2OUT1-AMMIX2OUT2}$ | 1.1   | 1.4 | - | V        |

Mixer output: pins AMMIX2OUT1 and AMMIX2OUT2

|       |                   |  |        |   |   |            |
|-------|-------------------|--|--------|---|---|------------|
| $R_o$ | output resistance |  | [6] 50 | - | - | k $\Omega$ |
|-------|-------------------|--|--------|---|---|------------|

Table 110. Dynamic characteristics of the tuner ...continued

 $V_{CC} = 8.5\text{ V}$ ;  $T_{amb} = 25\text{ °C}$ ; see [Figure 43](#); all AC values are given in RMS; unless otherwise specified.

| Symbol   | Parameter  | Conditions  | Min   | Typ | Max  | Unit                   |
|--|--|---|-------|-----|------|------------------------|
| $C_o$  | output capacitance   |   | [6] - | 3   | -    | pF                     |
| $V_{o(max)(p-p)}$                                      | maximum output voltage (peak-to-peak value)  | $V_{CCAMMIX2} = 8.5\text{ V}$   | -     | 12  | -    | V                      |
| $g_{m(conv)}$  | conversion transconductance $I_o/V_i$  |   | 1.2   | 1.6 | 2.1  | $\frac{mA}{V}$         |
| $g_{m(conv)(T)}$                                       | conversion transconductance variation with temperature related to $T_{amb} = 25\text{ °C}$ | $T_{amb} = -40\text{ °C to }+85\text{ °C}$  | -1    | 0   | +1   | dB                     |
| IP3  | 3rd-order intercept point  | $R_L = 1.5\text{ k}\Omega$ (AC load between output pins); $\Delta f = 300\text{ kHz}$                                 | 134   | 137 | -    | dB $\mu$ V             |
| IP2  | 2nd-order intercept point  | $R_L = 1.5\text{ k}\Omega$ (AC load between output pins)  | -     | 170 | -    | dB $\mu$ V             |
| $V_{i(n)(eq)}$   | equivalent input noise voltage   | $R_{gen} = 330\text{ }\Omega$ ; noise of $R_{gen}$ included; $R_L = 1.5\text{ k}\Omega$ (AC load between output pins) | -     | 15  | 22   | $\frac{nV}{\sqrt{Hz}}$ |
| F  | noise figure of AM mixer 2   |   | -     | 16  | 19.5 | dB                     |
| $I_{leak}$   | mixer leakage current  | FM mode;<br>$T_{amb} = -40\text{ °C to }+85\text{ °C}$  | -     | -   | 10   | $\mu$ A                |
| <b>AM IF2 AGC stage: pins AMIF2IN and AMIF2DEC</b> [5] |  |   |       |     |      |                        |
| $R_i$  | input resistance   |   | 1.6   | 2   | 2.4  | k $\Omega$             |
| $C_i$  | input capacitance  |   | -     | 5   | -    | pF                     |
| $V_i$  | input voltage  | for $\alpha = -10\text{ dB}$ audio attenuation at MPXAMOUT  | -     | 10  | 20   | $\mu$ V                |
| $V_{AGC(stop)}$  | AGC stop voltage (input carrier voltage)   |   | 100   | -   | -    | mV                     |
| <b>AM demodulator output: pin MPXAMOUT</b>             |  |   |       |     |      |                        |
| $V_{sens}$   | sensitivity voltage  | $m = 0.3$ ; $f_{mod} = 400\text{ Hz}$ ;<br>$B_{AF} = 2.15\text{ kHz}$ ; $R_{gen} = 2\text{ k}\Omega$                  |       |     |      |                        |
|  |  | (S+N)/N = 26 dB   | -     | 60  | 90   | $\mu$ V                |
|  |  | (S+N)/N = 46 dB   | -     | 600 | 900  | $\mu$ V                |
| (S+N)/N  | maximum signal plus noise-to-noise ratio   | $m = 0.3$ ; $f_{mod} = 400\text{ Hz}$ ;<br>$B_{AF} = 2.15\text{ kHz}$ ; $R_{gen} = 2\text{ k}\Omega$                  | 54    | 60  | -    | dB                     |
| $V_o$  | MPXAMOUT output voltage  | $m = 0.3$ ; $f_{mod} = 400\text{ Hz}$ ;<br>$V_i = 100\text{ }\mu$ V to 100 mV   | 200   | 255 | 320  | mV                     |
| THD  | total harmonic distortion  | $B_{AF} = 2.15\text{ kHz}$ ;<br>$V_{AMIF2IN} = 100\text{ }\mu$ V to 100 mV;<br>$m = 0.8$ ; $f_{mod} = 400\text{ Hz}$  | -     | 0.5 | 1    | %                      |
| $t_{st}$   | AM AGC settling time   | $V_{AMIF2IN} = 100\text{ }\mu$ V to 100 mV  | -     | 165 | -    | ms                     |
|  |  | $V_{AMIF2IN} = 100\text{ mV to }100\text{ }\mu$ V   | -     | 440 | -    | ms                     |
| $R_o$  | output resistance  |   | -     | -   | 500  | $\Omega$               |
| $C_o$  | output capacitance   |   | -     | 3   | -    | pF                     |
| $Z_L$  | load impedance   |   | 10    | -   | -    | k $\Omega$             |



**Table 110. Dynamic characteristics of the tuner ...continued**

$V_{CC} = 8.5\text{ V}$ ;  $T_{amb} = 25\text{ }^{\circ}\text{C}$ ; see [Figure 43](#); all AC values are given in RMS; unless otherwise specified.

| Symbol                                     | Parameter  | Conditions  | Min | Typ  | Max | Unit                             |
|--|--|---|-----|------|-----|----------------------------------|
| RR   | ripple rejection<br>$RR = \frac{V_{CC(\text{ripple})}}{V_{MPXAMOUT}}$  | $f_{\text{ripple}} = 100\text{ Hz}$ ;<br>$V_{CC(\text{ripple})} = 50\text{ mV (RMS)}$ ;<br>$V_{AMIF2IN} = 10\text{ mV}$   | 20  | 26   | -   | dB                               |
| <b>AM level detector output: pin LEVEL</b> |  |   |     |      |     |                                  |
| <i>Input: pins AMIF2IN and AMIF2DEC</i>    |  |   |     |      |     |                                  |
| LST  | level start alignment position   | $V_{i(AMIF2IN)} = 95\text{ }\mu\text{V}$ ; level slope aligned to<br>(800 ± 50) mV/20 dB; level start aligned to<br>$V_{LEVEL} = (1.24 \pm 0.04)\text{ V}$              | 6   | -    | 25  | -                                |
| $\Delta V_{LEVEL}$                         | step size for adjustment of level starting point                       | $V_{AMIF2IN} = 0\text{ V}$ ; default setting of level slope   | 20  | 40   | 72  | mV                               |
| LSL  | level slope alignment position   | level slope measured from<br>$V_{i(AMIF2IN)} = 95\text{ }\mu\text{V}$ to<br>$V_{i(AMIF2IN)} = 950\text{ }\mu\text{V}$ ; level slope aligned to<br>(800 ± 50) mV/20 dB   | 0   | -    | 7   | -                                |
| $\Delta V_{\text{step}}$                   | step size for adjustment of level slope                                | $V_{AMIF2IN} = 1.4\text{ mV}$   | 40  | 60   | 80  | $\frac{\text{mV}}{20\text{ dB}}$ |
| $\Delta V_{LEVEL(T)}$                      | level voltage drift over temperature                                   | $T_{amb} = -40\text{ }^{\circ}\text{C}$ to $+85\text{ }^{\circ}\text{C}$  | -   | 0.05 | -   | $\frac{\text{dB}}{\text{K}}$     |
| $R_o$                                      | output resistance  |   | -   | -    | 500 | $\Omega$                         |
| $R_L$                                      | output load resistance   |   | 25  | -    | -   | k $\Omega$                       |
| $C_{L(\text{max})}$                        | maximum load capacitance   |   | 25  | -    | -   | pF                               |
| RR   | ripple rejection<br>$RR = \frac{V_{CC(\text{ripple})}}{V_{LEVEL(AC)}}$ | $V_{CC(\text{ripple})} = 50\text{ mV (RMS)}$ ;<br>$f_{\text{ripple}} = 100\text{ Hz}$ ;<br>$V_{AMIF2IN} = 10\text{ mV}$   | -   | 24   | -   | dB                               |
| <b>AM noise blanker IF part</b>            |  |   |     |      |     |                                  |
| $t_{\text{sup}}$                           | suppression time at IF2  | IF2 = 450 kHz   | -   | 8    | -   | $\mu\text{s}$                    |
| $V_{\text{th}}$                            | noise blanker trigger threshold  | noise pulse at RF input (CISPR 16-1);<br>repetition rate = 100 Hz; pulse duration 5 ns; $t_r$ and $t_f < 1\text{ ns}$ ;<br>measured at dummy aerial input (15 pF/60 pF) |     |      |     |                                  |
|  |  | NBL[1:0] = 00   | -   | 1.4  | -   | V                                |
|  |  | NBL[1:0] = 01   | -   | 1.0  | -   | V                                |
|  |  | NBL[1:0] = 10   | -   | 0.7  | -   | V                                |
| $m_{\text{th}}$                            | modulation threshold for blanking of audio signal                      | maximum modulation, which triggers the blanking circuit in the audio part; LODX = 0   | -   | 5    | -   | %                                |

**Table 110. Dynamic characteristics of the tuner ...continued**

$V_{CC} = 8.5\text{ V}$ ;  $T_{amb} = 25\text{ °C}$ ; see [Figure 43](#); all AC values are given in RMS; unless otherwise specified.

| Symbol  | Parameter  | Conditions   | Min   | Typ                   | Max   | Unit                   |
|---|--|--|-------|-----------------------|-------|------------------------|
| <b>FM channel</b>   |  |  |       |                       |       |                        |
| FM RF AGC (FM distance mode; LODX = 0)  |  |  |       |                       |       |                        |
| <i>Inputs: pins FMMIX1IN1 and FMMIX1IN2<sup>[7]</sup></i>   |  |  |       |                       |       |                        |
| $V_{i(RF)}$   | RF input voltage for start of wideband AGC             | AGC[1:0] = 11  | -     | 9                     | -     | mV                     |
| <i>PIN diode drive output: pin IFMAGC</i>   |  |  |       |                       |       |                        |
| $I_{source(max)}$   | maximum AGC source current                             | AGC[1:0] = 00; KAGC = 0; $V_{i(RF)} > V_{AGC(start)}$ ; see <a href="#">Table 34</a> | -15   | -10                   | -7    | mA                     |
| $I_{sink(max)}$   | maximum AGC sink current at AGC recovery               | AGC[1:0] = 00; KAGC = 0  | 7     | 10                    | 15    | mA                     |
| $I_{source}$  | AGC source current                                     | AM mode; AGCSW = 1   | -6    | -4                    | -2.5  | mA                     |
|   |  | AM mode; AGCSW = 0   | -     | 0                     | -     | mA                     |
|   |  | LODX = 1 (FM local)  | -0.75 | -0.5                  | -0.35 | mA                     |
| <i>Voltage for narrow-band AGC: pin LEVEL</i>   |  |  |       |                       |       |                        |
| $V_{th}$  | threshold voltage for narrow-band AGC                  | KAGC = 1 (keyed AGC)   | 500   | 950                   | 1400  | mV                     |
| <b>FM mixer 1 (IF1 = 10.7 MHz)</b>  |  |  |       |                       |       |                        |
| <i>Mixer input: pins FMMIX1IN1 and FMMIX1IN2<sup>[7]</sup> and mixer output: pins MIX1OUT1 and MIX1OUT2<sup>[4]</sup></i> |  |  |       |                       |       |                        |
| $R_i$   | input resistance                                       | RFGAIN = 0   | 3     | 3.8                   | 4.7   | k $\Omega$             |
|   |  | RFGAIN = 1   | 1.6   | 2.0                   | 2.5   | k $\Omega$             |
| $C_i$   | input capacitance                                      |  | -     | 2                     | 4     | pF                     |
| $R_o$   | output resistance                                      |  | 100   | -                     | -     | k $\Omega$             |
| $C_o$   | output capacitance                                     |  | -     | 4                     | 6     | pF                     |
| $V_{i(RF)(max)}$  | maximum RF input voltage                               | 1 dB compression point of FM mixer output voltage                                    | 75    | 100                   | -     | mV                     |
| $V_{i(n)(eq)}$  | equivalent input noise voltage                         | $R_{gen} = 200\ \Omega$ ; noise of $R_{gen}$ included; $R_L = 2.6\text{ k}\Omega$    | -     | 2.7                   | 3.2   | $\frac{nV}{\sqrt{Hz}}$ |
| $g_{m(conv)}$   | conversion transconductance $I_o/V_i$                  | RFGAIN = 0   | 12    | 18                    | 25    | $\frac{mA}{V}$         |
|   |  | RFGAIN = 1   | 24    | 36                    | 50    | $\frac{mA}{V}$         |
| $g_{m(conv)(T)}$  | conversion transconductance variation with temperature |  | -     | $-0.2 \times 10^{-2}$ | -     | K <sup>-1</sup>        |
| F   | noise figure   | $R_{gen} = 300\ \Omega$  |       |                       |       |                        |
|   |  | $T_{amb} = -40\text{ °C}$  | -     | 2.8                   | -     | dB                     |
|   |  | $T_{amb} = 25\text{ °C}$   | -     | 3.1                   | 4.6   | dB                     |
|   |  | $T_{amb} = 85\text{ °C}$   | -     | 3.5                   | -     | dB                     |
| $R_{gen}$   | recommended generator resistance                       |  | -     | 200                   | -     | $\Omega$               |
| IP3   | 3rd-order intercept point                              | RFGAIN = 0   | -     | 120                   | -     | dB $\mu$ V             |

Table 110. Dynamic characteristics of the tuner ...continued

 $V_{CC} = 8.5\text{ V}$ ;  $T_{amb} = 25\text{ }^{\circ}\text{C}$ ; see Figure 43; all AC values are given in RMS; unless otherwise specified.

| Symbol                   | Parameter   | Conditions   | Min | Typ | Max | Unit |
|--------------------------|---|--|-----|-----|-----|------|
| IRR                      | image rejection ratio<br>$\frac{V_{\text{owanted}}}{V_{\text{oimage}}}$ | $f_{\text{RFwanted}} = 87.5\text{ MHz}$ ;<br>$f_{\text{RFimage}} = 108.9\text{ MHz}$ | 25  | 35  | -   | dB   |
| $V_{\text{o(max)(p-p)}}$ | maximum output voltage<br>(peak-to-peak value)                          |  | 4.5 | 5.6 | -   | V    |

**FM filter and demodulator****Tunable filter**

|                         |  |         |     |     |     |                              |
|-------------------------|--|---------|-----|-----|-----|------------------------------|
| $B_{\text{max}}$        | maximum bandwidth                                    | DYN = 1 | -   | 165 | -   | kHz                          |
|                         |  | DYN = 0 | -   | 165 | -   | kHz                          |
| $B_{\text{min}}$        | minimum bandwidth                                    | DYN = 1 | -   | 57  | -   | kHz                          |
|                         |  | DYN = 0 | -   | 57  | -   | kHz                          |
| $\Delta f_{\text{IF2}}$ | FM IF2 center frequency<br>alignment step size       |         | -   | 2   | -   | kHz                          |
| $f_{\text{IF2(T)}}$     | temperature<br>dependence of IF2<br>center frequency |         | -60 | -   | +60 | $\frac{\text{Hz}}{\text{K}}$ |

**FM demodulator***FM mixer 2 input: pins IF1IN and IF1DEC[5] and output: pin MPXAMOUT*

|                                   |  |  |     |     |     |               |
|-----------------------------------|--|--|-----|-----|-----|---------------|
| $R_i$                             | input resistance   |  | 275 | 330 | 400 | $\Omega$      |
| $R_o$                             | output resistance  |  | -   | -   | 500 | $\Omega$      |
| $R_L$                             | load resistance  |  | 20  | -   | -   | k $\Omega$    |
| $C_L$                             | load capacitance   |  | -   | -   | 20  | pF            |
| $V_{i(\text{max})}$               | maximum input voltage  |  | -   | 280 | -   | mV            |
| $V_{i(\text{start})(\text{lim})}$ | input voltage for start of<br>limiting of $V_{\text{MPXAMOUT}}$            | $\alpha_{\text{AF}} = -3\text{ dB}$  | -   | 2.3 | -   | $\mu\text{V}$ |
| $V_{i(\text{sens})}$              | sensitivity input voltage  | $\Delta f = 22.5\text{ kHz}$ ; $f_{\text{mod}} = 1\text{ kHz}$ ;<br>de-emphasis = 50 $\mu\text{s}$   | -   | 5   | -   | $\mu\text{V}$ |
|                                   |  | (S+N)/N = 26 dB;<br>$R_{\text{gen}} = 330\ \Omega$   | -   | 41  | -   | $\mu\text{V}$ |
|                                   |  | (S+N)/N = 46 dB  | -   | 41  | -   | $\mu\text{V}$ |
| (S+N)/N                           | ultimate signal plus<br>noise-to-noise ratio on<br>pin MPXAMOUT            | $\Delta f = 22.5\text{ kHz}$ ; $f_{\text{mod}} = 1\text{ kHz}$ ;<br>$V_i = 3\text{ mV}$ ;<br>de-emphasis = 50 $\mu\text{s}$ ;<br>B = 300 Hz to 22 kHz                    | 75  | 78  | -   | dB            |
| THD                               | total harmonic distortion<br>of $V_{\text{MPXAMOUT}}$                      | $\Delta f = 75\text{ kHz}$ ; $f_{\text{mod}} = 1\text{ kHz}$ ;<br>$V_i = 10\text{ mV}$   | -   | 0.5 | 1   | %             |
| $\Delta f_{\text{max}}$           | maximum FM deviation   | THD = 3 %; $f_{\text{mod}} = 1\text{ kHz}$ ;<br>$V_i = 10\text{ mV}$   | 120 | 180 | -   | kHz           |
| $\alpha_{\text{AM}}$              | AM suppression<br>$\frac{V_{\text{MPXAMOUT(FM)}}}{V_{\text{MPXAMOUT(AM)}}$ | FM reference: $\Delta f = 22.5\text{ kHz}$ ;<br>$f_{\text{mod}} = 1\text{ kHz}$ ;<br>AM: $m = 0.3$ ; $f_{\text{mod}} = 1\text{ kHz}$ ;<br>de-emphasis = 50 $\mu\text{s}$ | -   | 40  | -   | dB            |
|                                   |  | $10\ \mu\text{V} < V_i < 1\text{ V}$   | -   | 40  | -   | dB            |
|                                   |  | $100\ \mu\text{V} < V_i < 1\text{ V}$  | -   | 50  | -   | dB            |

**Table 110. Dynamic characteristics of the tuner ...continued** $V_{CC} = 8.5\text{ V}$ ;  $T_{amb} = 25\text{ }^{\circ}\text{C}$ ; see [Figure 43](#); all AC values are given in RMS; unless otherwise specified.

| Symbol    | Parameter                                  | Conditions  | Min | Typ | Max | Unit |
|-----------|--|---|-----|-----|-----|------|
| $V_o$     | output voltage                             | $V_i = 20\text{ }\mu\text{V}$ to 1 V  |     | [4] |     |      |
|           |  | $\Delta f = 1.2\text{ kHz}$ ; $f_{mod} = 57\text{ kHz}$   | -   | 7   | -   | mV   |
|           |  | $\Delta f = 22.5\text{ kHz}$ ; $f_{mod} = 1\text{ kHz}$   | 180 | 230 | 290 | mV   |
| $f_{cut}$ | cut-off frequency                          | $C_L = 0\text{ F}$ ; $R_L > 20\text{ k}\Omega$  | -   | 65  | -   | kHz  |
| RR        | ripple rejection                           | $f_{ripple} = 100\text{ Hz}$ to 20 kHz;<br>$V_{CC(ripple)} = 50\text{ mV}$ ;<br>$V_{IF1IN} = 3\text{ mV}$ | -   | 36  | -   | dB   |
|           | $RR = \frac{V_{CC(ripple)}}{V_{MPXAMOUT}}$ |   |     |     |     |      |

**FM level detector output: pin LEVEL[5]**

|                    |   |   |    |    |     |                                  |
|--------------------|---|---|----|----|-----|----------------------------------|
| $R_o$              | output resistance                           |   | -  | -  | 500 | $\Omega$                         |
| $R_L$              | load resistance                             |   | 25 | -  | -   | k $\Omega$                       |
| $C_L$              | load capacitance                            |   | -  | -  | 25  | pF                               |
| LST                | level start alignment position              | $V_{i(IF1IN)} = 135\text{ }\mu\text{V}$ ; level slope aligned to (800 $\pm$ 50) mV/20 dB; level start aligned to $V_{LEVEL} = (1.47 \pm 0.04)\text{ V}$ | 6  | -  | 25  | -                                |
| $\Delta V_{LEVEL}$ | step size of level start adjustment         | LSL[2:0] = 100  | 20 | 40 | 72  | mV                               |
| LSL                | level slope alignment position              | level slope measured from $V_{i(IF1IN)} = 135\text{ }\mu\text{V}$ to $V_{i(IF1IN)} = 1.35\text{ mV}$ ; level slope aligned to (800 $\pm$ 50) mV/20 dB   | 0  | -  | 7   | -                                |
| $\Delta V_{step}$  | step size of level slope adjustment         | $V_i = 1\text{ mV}$   | 40 | 60 | 80  | $\frac{\text{mV}}{20\text{ dB}}$ |
| RR                 | ripple rejection                            | $V_{CC(ripple)} = 50\text{ mV}$ ;<br>$f_{ripple} = 100\text{ Hz}$   | -  | 25 | -   | dB                               |
|                    | $RR = \frac{V_{CC(ripple)}}{V_{level(AC)}}$ |   |    |    |     |                                  |

**IF counter (FM IF2 or AM IF2 counter); see [Table 8](#)****Pins IF1IN and IF1DEC[5]**

|               |                     |         |   |   |    |               |
|---------------|---------------------|---------|---|---|----|---------------|
| $V_{i(sens)}$ | sensitivity voltage | FM mode | - | 5 | 10 | $\mu\text{V}$ |
|---------------|---------------------|---------|---|---|----|---------------|

**Pins AMIF2IN and AMIF2DEC[8]**

|               |                     |                  |   |    |     |               |
|---------------|---------------------|------------------|---|----|-----|---------------|
| $V_{i(sens)}$ | sensitivity voltage | AM mode; $m = 0$ | - | 70 | 260 | $\mu\text{V}$ |
|---------------|---------------------|------------------|---|----|-----|---------------|

[1] Measured between pins XTAL1 and XTAL2.

[2] Conversion gain formula of DAA:  $V_{DAAOUT} = \left(1.915 \times \frac{n}{128} + 0.1\right) \times V_{VTUNE}$  where  $n = 0$  to 127.

[3] Input parameters of AM mixer 1 measured between pins AMMIX1IN and AMMIX1DEC.

[4] Output parameters of FM and AM mixer 1 measured between pins MIX1OUT1 and MIX1OUT2.

[5] Input parameters of FM mixer 2 measured between pins IF1IN and IF1DEC.

[6] Output parameters of AM mixer 2 measured between pins AMMIX2OUT1 and AMMIX2OUT2.

[7] Input parameters of FM mixer 1 measured between pins FMMIX1IN1 and FMMIX1IN2.

[8] Input parameters of AM mixer 2 measured between pins AMIF2IN and AMIF2DEC.

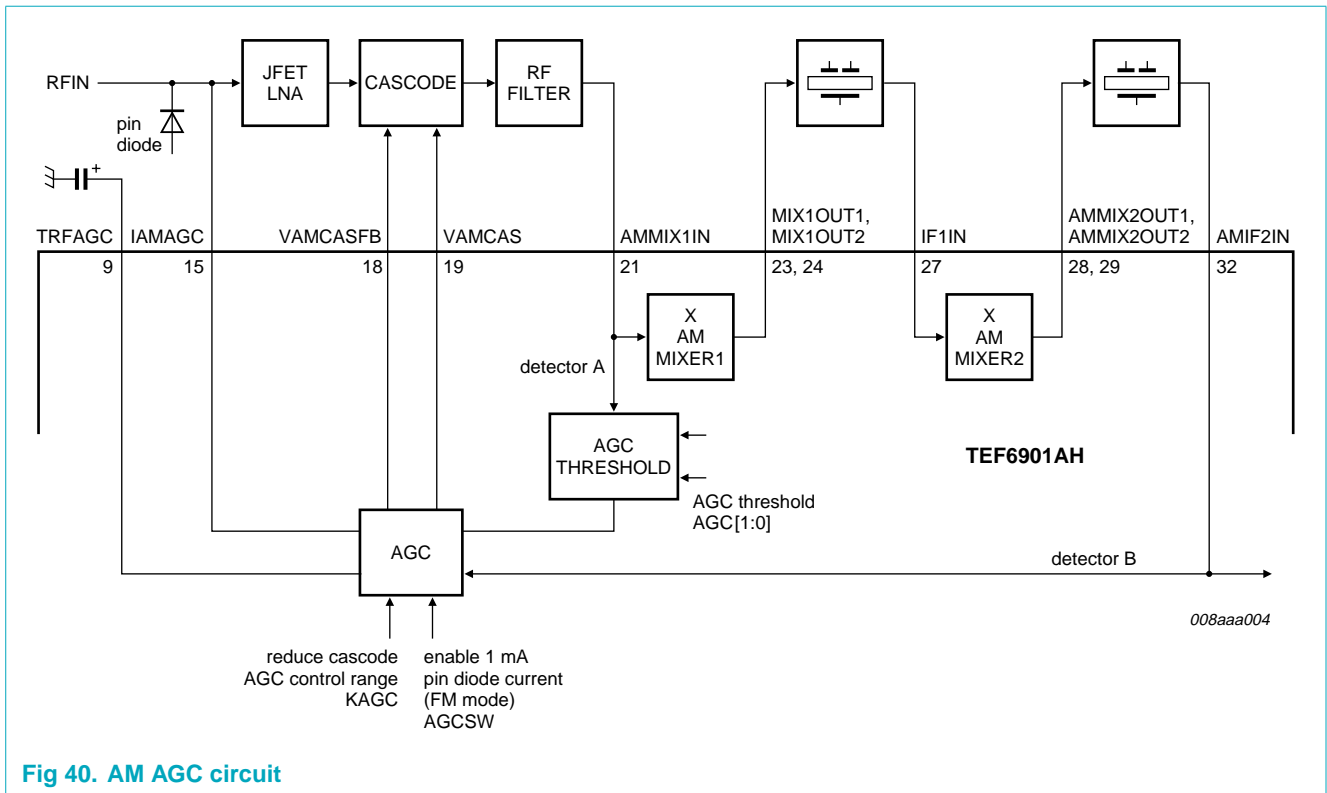

## 12.2 Dynamic characteristics of the sound processor

**Table 111. Dynamic characteristics of the sound processor**

$V_{CC} = 8.5\text{ V}$ ;  $T_{amb} = 25\text{ }^\circ\text{C}$ ; see [Figure 43](#); all AC values are given in RMS; treble: 10 kHz filter frequency; treble = 0 dB; bass: 60 Hz filter frequency; bass = 0 dB;  $f_{audio} = 1\text{ kHz}$ ;  $G_{vol} = 0\text{ dB}$ ;  $G_{fader} = 0\text{ dB}$ ; loudness off; standard output gain (byte OUTPUT; bit OUTA = 0);  $R_L = 10\text{ k}\Omega$ ;  $C_L = 1\text{ nF}$ ; unless otherwise specified.

| Symbol                            | Parameter                                       | Conditions  | Min | Typ | Max | Unit |
|-----------------------------------|---|---|-----|-----|-----|------|
| <b>Stereo decoder and AM path</b> |   |   |     |     |     |      |
| $V_{O(FM)}$                       | FM mono output voltage on pins LFOUT and RFOUT  | $f_{MPXAMOUT} = 1\text{ kHz}$ ;<br>30 % FM modulation without pilot                   | -   | 330 | -   | mV   |
| $V_{O(AM)}$                       | AM output voltage on pins LFOUT and RFOUT       | $f_{AM} = 1\text{ kHz}$ ;<br>30 % AM modulation                                       | -   | 365 | -   | mV   |
| $\alpha_{cs}$                     | channel separation                              | $f_{FMMPX} = 1\text{ kHz}$  | 40  | -   | -   | dB   |
| $g_{f(L-R)}$                      | stereo adjust for fine adjustment of separation | measure 1 kHz level for L – R modulation; compare to 1 kHz level for L + R modulation |     |     |     |      |
|                                   |   | CSA[3:0] = 0000   | -   | 0   | -   | dB   |
|                                   |   | CSA[3:0] = 0001   | -   | 0.2 | -   | dB   |
|                                   |   | :   | -   | :   | -   | dB   |
|                                   |   | CSA[3:0] = 1110   | -   | 2.8 | -   | dB   |
|                                   |   | CSA[3:0] = 1111   | -   | 3.0 | -   | dB   |

**Table 111. Dynamic characteristics of the sound processor ...continued**

$V_{CC} = 8.5\text{ V}$ ;  $T_{amb} = 25\text{ }^{\circ}\text{C}$ ; see [Figure 43](#); all AC values are given in RMS; treble: 10 kHz filter frequency; treble = 0 dB; bass: 60 Hz filter frequency; bass = 0 dB;  $f_{audio} = 1\text{ kHz}$ ;  $G_{vol} = 0\text{ dB}$ ;  $G_{fader} = 0\text{ dB}$ ; loudness off; standard output gain (byte OUTPUT; bit OUTA = 0);  $R_L = 10\text{ k}\Omega$ ;  $C_L = 1\text{ nF}$ ; unless otherwise specified.

| Symbol               | Parameter  | Conditions   | Min  | Typ  | Max  | Unit          |
|----------------------|--|--|------|------|------|---------------|
| S/N                  | signal-to-noise ratio  | $f_{MPXAMIN} = 20\text{ Hz to }15\text{ kHz}$ ;<br>referenced to 1 kHz at<br>91 % FM modulation;<br>DEMP = 1 | 70   | -    | -    | dB            |
| THD                  | total harmonic distortion  | FM mode; DEMP = 1;<br>measured with 15 kHz<br>brick-wall low-pass filter                                     |      |      |      |               |
|                      |  | $f_{MPXAMIN} = 200\text{ Hz to }15\text{ kHz}$   | -    | -    | 0.3  | %             |
|                      |  | $V_{MPXAMIN} = 50\%$ ; L; pilot on   | -    | -    | 0.3  | %             |
|                      |  | $V_{MPXAMIN} = 50\%$ ; R;<br>pilot on  | -    | -    | 0.3  | %             |
| $V_{o(bal)}$         | mono channel balance<br>$\frac{V_{oL}}{V_{oR}}$                                    | FM mode  | -1   | -    | +1   | dB            |
| $\alpha_{19}$        | pilot signal suppression   | 9 % pilot; $f_{pilot} = 19\text{ kHz}$ ;<br>referenced to 1 kHz at<br>91 % FM modulation;<br>DEMP = 1        | 40   | 50   | -    | dB            |
| $\alpha$             | subcarrier suppression   | modulation off; referenced to<br>1 kHz at 91 % FM modulation   |      |      |      |               |
|                      |  | $f_{sc} = 38\text{ kHz}$   | 35   | 50   | -    | dB            |
|                      |  | $f_{sc} = 57\text{ kHz}$   | 40   | -    | -    | dB            |
|                      |  | $f_{sc} = 76\text{ kHz}$   | 50   | 60   | -    | dB            |
| PSRR                 | power supply ripple<br>rejection   | FM mode; $f_{ripple} = 100\text{ Hz}$ ;<br>$V_{CC(AC)} = V_{ripple} = 100\text{ mV}$<br>(RMS)                | 24   | -    | -    | dB            |
| $\Delta V_{out}$     | frequency response   | FM mode  |      |      |      |               |
|                      |  | $f_{MPXAMIN} = 20\text{ Hz}$   | -0.5 | -    | +0.5 | dB            |
|                      |  | $f_{MPXAMIN} = 20\text{ kHz}$  | -0.5 | -    | +0.5 | dB            |
| $f_{cut(de-em)}$     | cut-off frequency of<br>de-emphasis filter   | -3 dB point; see <a href="#">Figure 31</a>   |      |      |      |               |
|                      |  | DEMP = 1 ( $\tau = 50\text{ }\mu\text{s}$ )  | -    | 3.18 | -    | kHz           |
|                      |  | DEMP = 0 ( $\tau = 75\text{ }\mu\text{s}$ )  | -    | 2.12 | -    | kHz           |
| $m_{i(pilot)}$       | pilot threshold<br>modulation for automatic<br>switching by pilot input<br>voltage | stereo   |      |      |      |               |
|                      |  | on   | -    | 4.0  | 5.5  | %             |
|                      |  | off  | 1.3  | 2.7  | -    | %             |
| $hys_{pilot}$        | hysteresis of pilot<br>threshold voltage   |  | -    | 2    | -    | dB            |
| <b>Noise blanker</b> |  |  |      |      |      |               |
| <b>FM part</b>       |  |  |      |      |      |               |
| $t_{sup(min)}$       | minimum suppression<br>time  |  | -    | 15   | -    | $\mu\text{s}$ |

**Table 111. Dynamic characteristics of the sound processor ...continued**

$V_{CC} = 8.5\text{ V}$ ;  $T_{amb} = 25\text{ °C}$ ; see [Figure 43](#); all AC values are given in RMS; treble: 10 kHz filter frequency; treble = 0 dB; bass: 60 Hz filter frequency; bass = 0 dB;  $f_{audio} = 1\text{ kHz}$ ;  $G_{vol} = 0\text{ dB}$ ;  $G_{fader} = 0\text{ dB}$ ; loudness off; standard output gain (byte OUTPUT; bit OUTA = 0);  $R_L = 10\text{ k}\Omega$ ;  $C_L = 1\text{ nF}$ ; unless otherwise specified.

| Symbol                        | Parameter  | Conditions   | Min   | Typ           | Max | Unit  |               |
|-------------------------------|--|--|---|---------------|-----|-------|---------------|
| $V_{MPXAMIN(M)}$              | noise blanker sensitivity at MPXAMIN input (peak value of noise pulses)            | $t_{pulse} = 10\text{ }\mu\text{s}$ ; $f_{pulse} = 100\text{ Hz}$  |   |               |     |       |               |
|                               |  | NBS[1:0] = 00  | -   | 65            | -   | mV    |               |
|                               |  | NBS[1:0] = 01  | -   | 100           | -   | mV    |               |
|                               |  | NBS[1:0] = 10  | -   | 125           | -   | mV    |               |
| $V_{LEVEL(M)}$                | noise blanker sensitivity at LEVEL output (peak value of noise pulses) (test mode) | $t_{pulse} = 10\text{ }\mu\text{s}$ ; $f_{pulse} = 100\text{ Hz}$  |   |               |     |       |               |
|                               |  | NBL[1:0] = 00  | -   | 10            | -   | mV    |               |
|                               |  | NBL[1:0] = 01  | -   | 25            | -   | mV    |               |
|                               |  | NBL[1:0] = 10  | -   | 36            | -   | mV    |               |
|                               |  | NBL[1:0] = 11  | -   | 50            | -   | mV    |               |
|                               |  | <b>AM audio part</b>   |   |               |     |       |               |
|                               |  | $t_{sup(min)}$   | minimum suppression time  | -             | 200 | -     | $\mu\text{s}$ |
|                               |  | $M_{AM}$   | noise blanker sensitivity; triggered from pulses at MPXAMIN slew rate | NBS[1:0] = 00 | -   | 16.5  | -             |
| NBS[1:0] = 01                 | -  |  |   | 18.6          | -   | V/ms  |               |
| NBS[1:0] = 10                 | -  |  |   | 21            | -   | V/ms  |               |
| NBS[1:0] = 11                 | -  |  |   | 23.5          | -   | V/ms  |               |
| <b>Weak signal processing</b> |  |  |   |               |     |       |               |
| <b>Detectors</b>              |  |  |   |               |     |       |               |
| $V_{eq(USN)}$                 | USN sensitivity equivalent level voltage<br>$\frac{V_{eq(USN)}}{\Delta f}$         | see <a href="#">Figure 24</a> ;<br>$f_{MPXAMOUT} = 150\text{ kHz}$ ;<br>$V_{MPXAMOUT} = 250\text{ mV}$ ;<br>HCMP = 1             |   |               |     |       |               |
|                               |  | USS[1:0] = 00  | -   | -0.06         | -   | V/kHz |               |
|                               |  | USS[1:0] = 01  | -   | -0.08         | -   | V/kHz |               |
|                               |  | USS[1:0] = 10  | -   | -0.12         | -   | V/kHz |               |
| $V_{eq(WAM)}$                 | WAM sensitivity equivalent level voltage<br>$\frac{V_{eq(WAM)}}{V_{LEVEL(p-p)}}$   | see <a href="#">Figure 24</a> ;<br>$V_{LEVEL} = 200\text{ mV (p-p)}$ at<br>$f = 21\text{ kHz}$ on the level<br>voltage; HCMP = 1 |   |               |     |       |               |
|                               |  | WAS[1:0] = 00  | -   | -7.5          | -   | -     |               |
|                               |  | WAS[1:0] = 01  | -   | -10           | -   | -     |               |
|                               |  | WAS[1:0] = 10  | -   | -15           | -   | -     |               |
|                               |  | WAS[1:0] = 11  | -   | -20           | -   | -     |               |

**Table 111. Dynamic characteristics of the sound processor ...continued**

$V_{CC} = 8.5\text{ V}$ ;  $T_{amb} = 25\text{ °C}$ ; see [Figure 43](#); all AC values are given in RMS; treble: 10 kHz filter frequency; treble = 0 dB; bass: 60 Hz filter frequency; bass = 0 dB;  $f_{audio} = 1\text{ kHz}$ ;  $G_{vol} = 0\text{ dB}$ ;  $G_{fader} = 0\text{ dB}$ ; loudness off; standard output gain (byte OUTPUT; bit OUTA = 0);  $R_L = 10\text{ k}\Omega$ ;  $C_L = 1\text{ nF}$ ; unless otherwise specified.

| Symbol   | Parameter   | Conditions   | Min | Typ | Max | Unit |
|--|---|--|-----|-----|-----|------|
| <b>Setting of time constants for SNC, MUTE and HCC</b> |   |  |     |     |     |      |
| $t_{USN(attack)}$                                      | USN detector attack time  | soft mute and SNC  | -   | 1   | -   | ms   |
| $t_{USN(recovery)}$                                    | USN detector recovery time  | soft mute and SNC  | -   | 1   | -   | ms   |
| $\Delta USS$   | USN detector desensitization  | USN sensitivity setting (USS) versus level voltage (USN sensitivity setting is automatically reduced as level voltage decreases) |     |     |     |      |
|  |   | $V_{LEVEL} > 1.25\text{ V}$  | -   | -   | 3   | -    |
|  |   | $1.25\text{ V} > V_{LEVEL} > 1.125\text{ V}$   | -   | -   | 2   | -    |
|  |   | $1.125\text{ V} > V_{LEVEL} > 1.0\text{ V}$  | -   | -   | 1   | -    |
|  |   | $1.0\text{ V} > V_{LEVEL}$   | -   | -   | 0   | -    |
| $t_{WAM(attack)}$                                      | WAM detector attack time (SNC)  |  | -   | 1   | -   | ms   |
| $t_{WAM(recovery)}$                                    | WAM detector recovery time (SNC)                                      |  | -   | 1   | -   | ms   |
| $t_{peak(USN)(attack)}$                                | peak detector attack time for USN read-out via I <sup>2</sup> C-bus   |  | -   | 1   | -   | ms   |
| $t_{peak(USN)(recovery)}$                              | peak detector recovery time for USN read-out via I <sup>2</sup> C-bus |  | -   | 10  | -   | ms   |
| $t_{peak(WAM)(attack)}$                                | peak detector attack time for WAM read-out via I <sup>2</sup> C-bus   |  | -   | 1   | -   | ms   |
| $t_{peak(WAM)(recovery)}$                              | peak detector recovery time for WAM read-out via I <sup>2</sup> C-bus |  | -   | 10  | -   | ms   |



**Table 111. Dynamic characteristics of the sound processor ...continued**

$V_{CC} = 8.5\text{ V}$ ;  $T_{amb} = 25\text{ °C}$ ; see [Figure 43](#); all AC values are given in RMS; treble: 10 kHz filter frequency; treble = 0 dB; bass: 60 Hz filter frequency; bass = 0 dB;  $f_{audio} = 1\text{ kHz}$ ;  $G_{vol} = 0\text{ dB}$ ;  $G_{fader} = 0\text{ dB}$ ; loudness off; standard output gain (byte OUTPUT; bit OUTA = 0);  $R_L = 10\text{ k}\Omega$ ;  $C_L = 1\text{ nF}$ ; unless otherwise specified.

| Symbol                   | Parameter               | Conditions   | Min | Typ  | Max | Unit |
|--------------------------|-------------------------|--|-----|------|-----|------|
| <b>Control functions</b> |                         |  |     |      |     |      |
| $V_{start(mute)}$        | soft mute start voltage | FM mode; see <a href="#">Figure 28</a> ;<br>equivalent level voltage that<br>causes $\alpha_{mute} = 3\text{ dB}$ ;<br>MSL[1:0] = 11 |     |      |     |      |
|                          |                         | MST[2:0] = 000   | -   | 0.75 | -   | V    |
|                          |                         | MST[2:0] = 001   | -   | 0.88 | -   | V    |
|                          |                         | MST[2:0] = 010   | -   | 1    | -   | V    |
|                          |                         | MST[2:0] = 011   | -   | 1.12 | -   | V    |
|                          |                         | MST[2:0] = 100   | -   | 1.25 | -   | V    |
|                          |                         | MST[2:0] = 101   | -   | 0.68 | -   | V    |
|                          |                         | MST[2:0] = 110   | -   | 0.73 | -   | V    |
|                          |                         | MST[2:0] = 111   | -   | 0.85 | -   | V    |
|                          |                         | AM mode; see <a href="#">Figure 29</a> ;<br>equivalent level voltage that<br>causes $\alpha_{mute} = 3\text{ dB}$ ;<br>MSL[1:0] = 11 |     |      |     |      |
|                          |                         | MST[2:0] = 000   | -   | 1.35 | -   | V    |
|                          |                         | MST[2:0] = 001   | -   | 1.58 | -   | V    |
|                          |                         | MST[2:0] = 010   | -   | 1.80 | -   | V    |
|                          |                         | MST[2:0] = 011   | -   | 1.12 | -   | V    |
|                          |                         | MST[2:0] = 100   | -   | 1.25 | -   | V    |
|                          |                         | MST[2:0] = 101   | -   | 1.50 | -   | V    |
|                          |                         | MST[2:0] = 110   | -   | 1.70 | -   | V    |
|                          |                         | MST[2:0] = 111   | -   | 1.91 | -   | V    |

**Table 111. Dynamic characteristics of the sound processor ...continued**

$V_{CC} = 8.5\text{ V}$ ;  $T_{amb} = 25\text{ }^{\circ}\text{C}$ ; see [Figure 43](#); all AC values are given in RMS; treble: 10 kHz filter frequency; treble = 0 dB; bass: 60 Hz filter frequency; bass = 0 dB;  $f_{audio} = 1\text{ kHz}$ ;  $G_{vol} = 0\text{ dB}$ ;  $G_{fader} = 0\text{ dB}$ ; loudness off; standard output gain (byte OUTPUT; bit OUTA = 0);  $R_L = 10\text{ k}\Omega$ ;  $C_L = 1\text{ nF}$ ; unless otherwise specified.

| Symbol               | Parameter   | Conditions  | Min | Typ  | Max  | Unit |
|----------------------|---|---|-----|------|------|------|
| $C_{mute}$           | soft mute slope<br>$C_{mute} = \frac{\Delta\alpha_{mute}}{\Delta V_{eq.LEVEL}}$   | FM mode; see <a href="#">Figure 28</a> ;<br>slope of soft mute attenuation<br>with respect to equivalent level<br>voltage; MST[2:0] = 000 |     |      |      |      |
|                      |   | MSLE = 0; MSL[1:0] = 00   | -   | 8    | -    | dB/V |
|                      | MSLE = 0; MSL[1:0] = 01   | -   | 16  | -    | dB/V |      |
|                      | MSLE = 0; MSL[1:0] = 10   | -   | 24  | -    | dB/V |      |
|                      | MSLE = 0; MSL[1:0] = 11   | -   | 32  | -    | dB/V |      |
|                      | MSLE = 1; MSL[1:0] = 00   | -   | 40  | -    | dB/V |      |
|                      | MSLE = 1; MSL[1:0] = 01   | -   | 48  | -    | dB/V |      |
|                      | AM mode; see <a href="#">Figure 29</a> ;<br>slope of soft mute attenuation<br>with respect to equivalent level<br>voltage; MST[2:0] = 011 |   |     |      |      |      |
|                      | MSLE = 0; MSL[1:0] = 00   | -   | 8   | -    | dB/V |      |
|                      | MSLE = 0; MSL[1:0] = 01   | -   | 12  | -    | dB/V |      |
|                      | MSLE = 0; MSL[1:0] = 10   | -   | 16  | -    | dB/V |      |
|                      | MSLE = 0; MSL[1:0] = 11   | -   | 20  | -    | dB/V |      |
|                      | MSLE = 1; MSL[1:0] = 00   | -   | 24  | -    | dB/V |      |
|                      | MSLE = 1; MSL[1:0] = 01   | -   | 28  | -    | dB/V |      |
|                      | MSLE = 1; MSL[1:0] = 10   | -   | 32  | -    | dB/V |      |
|                      | MSLE = 1; MSL[1:0] = 11   | -   | 36  | -    | dB/V |      |
| $\alpha_{mute(max)}$ | maximum soft mute<br>attenuation by USN   | see <a href="#">Figure 30</a> ;<br>$f_{MPXAMOUT} = 150\text{ kHz}$ ;<br>$V_{MPXAMOUT} = 0.6\text{ V (RMS)}$ ;<br>USS[1:0] = 11            |     |      |      |      |
|                      |   | UMD[1:0] = 00   | -   | 3    | -    | dB   |
|                      |   | UMD[1:0] = 01   | -   | 6    | -    | dB   |
|                      |   | UMD[1:0] = 10   | -   | 9    | -    | dB   |
|                      |   | UMD[1:0] = 11   | -   | 12   | -    | dB   |
| $V_{start(SNC)}$     | SNC stereo blend start<br>voltage   | see <a href="#">Figure 25</a> ; equivalent level<br>voltage that causes channel<br>separation is 10 dB;<br>SSL[1:0] = 10                  |     |      |      |      |
|                      |   | SST[3:0] = 0000   | -   | 1.5  | -    | V    |
|                      |   | :   | -   | :    | -    | V    |
|                      |   | SST[3:0] = 1000   | -   | 2.0  | -    | V    |
|                      |   | :   | -   | :    | -    | V    |
|                      |   | SST[3:0] = 1111   | -   | 2.45 | -    | V    |

**Table 111. Dynamic characteristics of the sound processor ...continued**

$V_{CC} = 8.5\text{ V}$ ;  $T_{amb} = 25\text{ °C}$ ; see [Figure 43](#); all AC values are given in RMS; treble: 10 kHz filter frequency; treble = 0 dB; bass: 60 Hz filter frequency; bass = 0 dB;  $f_{audio} = 1\text{ kHz}$ ;  $G_{vol} = 0\text{ dB}$ ;  $G_{fader} = 0\text{ dB}$ ; loudness off; standard output gain (byte OUTPUT; bit OUTA = 0);  $R_L = 10\text{ k}\Omega$ ;  $C_L = 1\text{ nF}$ ; unless otherwise specified.

| Symbol              | Parameter   | Conditions  | Min | Typ       | Max | Unit |
|---------------------|---|---|-----|-----------|-----|------|
| $C_{SNC}$           | SNC slope<br>$C_{SNC} = \frac{\Delta\alpha_{cs}}{\Delta V_{eq.LEVEL}}$            | see <a href="#">Figure 25</a> ; slope of channel separation between 30 dB and 10 dB with respect to level voltage; SST[3:0] = 1010              |     |           |     |      |
|                     |   | SSL[1:0] = 00   | -   | 38        | -   | dB/V |
|                     |   | SSL[1:0] = 01   | -   | 51        | -   | dB/V |
|                     |   | SSL[1:0] = 10   | -   | 63        | -   | dB/V |
|                     |   | SSL[1:0] = 11   | -   | 72        | -   | dB/V |
| $V_{start(HCC)}$    | HCC start voltage   | see <a href="#">Figure 26</a> ; $f_{audio} = 10\text{ kHz}$ ; equivalent level voltage that causes $\alpha_{HCC} = 3\text{ dB}$ ; HSL[1:0] = 10 |     |           |     |      |
|                     |   | HST[2:0] = 000  | -   | 1.17      | -   | V    |
|                     |   | HST[2:0] = 001  | -   | 1.42      | -   | V    |
|                     |   | HST[2:0] = 010  | -   | 1.67      | -   | V    |
|                     |   | HST[2:0] = 011  | -   | 1.92      | -   | V    |
|                     |   | HST[2:0] = 100  | -   | 2.17      | -   | V    |
|                     |   | HST[2:0] = 101  | -   | 2.67      | -   | V    |
|                     |   | HST[2:0] = 110  | -   | 3.17      | -   | V    |
|                     |   | HST[2:0] = 111  | -   | 3.67      | -   | V    |
| $C_{HCC}$           | HCC slope<br>$C_{HCC} = \frac{\Delta\alpha_{10\text{ kHz}}}{\Delta V_{eq.LEVEL}}$ | see <a href="#">Figure 26</a> ; $f_{audio} = 10\text{ kHz}$ ; HST[2:0] = 010  |     |           |     |      |
|                     |   | HSL[1:0] = 00   | -   | 9         | -   | dB/V |
|                     |   | HSL[1:0] = 01   | -   | 11        | -   | dB/V |
|                     |   | HSL[1:0] = 10   | -   | 14        | -   | dB/V |
|                     |   | HSL[1:0] = 11   | -   | 18        | -   | dB/V |
| $\alpha_{HCC(max)}$ | maximum HCC attenuation   | see <a href="#">Figure 26</a> ; $f_{audio} = 10\text{ kHz}$   |     |           |     |      |
|                     |   | HCSF = 1; HCSFH = 0   | -   | 10        | -   | dB   |
|                     |   | HCSF = 0; HCSFH = 0   | -   | 14        | -   | dB   |
| $f_{cut}$           | cut-off frequency of fixed HCC  | see <a href="#">Figure 27</a> ; -3 dB point (first order filter)  |     |           |     |      |
|                     |   | HCF[2:0] = 000  | -   | reserved  | -   | kHz  |
|                     |   | HCF[2:0] = 001  | -   | 2         | -   | kHz  |
|                     |   | HCF[2:0] = 010  | -   | 3         | -   | kHz  |
|                     |   | HCF[2:0] = 011  | -   | 5         | -   | kHz  |
|                     |   | HCF[2:0] = 100  | -   | 7         | -   | kHz  |
|                     |   | HCF[2:0] = 101  | -   | 10        | -   | kHz  |
|                     |   | HCF[2:0] = 110  | -   | wide      | -   | -    |
|                     |   | HCF[2:0] = 111  | -   | unlimited | -   | -    |

**Table 111. Dynamic characteristics of the sound processor ...continued**

$V_{CC} = 8.5$  V;  $T_{amb} = 25$  °C; see [Figure 43](#); all AC values are given in RMS; treble: 10 kHz filter frequency; treble = 0 dB; bass: 60 Hz filter frequency; bass = 0 dB;  $f_{audio} = 1$  kHz;  $G_{vol} = 0$  dB;  $G_{fader} = 0$  dB; loudness off; standard output gain (byte OUTPUT; bit OUTA = 0);  $R_L = 10$  k $\Omega$ ;  $C_L = 1$  nF; unless otherwise specified.

| Symbol  | Parameter  | Conditions   | Min | Typ  | Max | Unit       |
|---|--|--|-----|------|-----|------------|
| <b>Analog-to-digital converters for I<sup>2</sup>C-bus</b>                          |  |  |     |      |     |            |
| Level analog-to-digital converter (8-bit); see <a href="#">Table 10</a>             |  |  |     |      |     |            |
| $V_{LEVEL(min)}$  | lower voltage limit of conversion range  |  | -   | 0.25 | -   | V          |
| $V_{LEVEL(max)}$  | upper voltage limit of conversion range  |  | -   | 4.25 | -   | V          |
| $\Delta V_{LEVEL}$  | bit resolution voltage   |  | -   | 15.7 | -   | mV         |
| Ultrasonic noise analog-to-digital converter (4-bit); see <a href="#">Figure 24</a> |  |  |     |      |     |            |
| $\Delta f_{USN(min)}$   | conversion range lower deviation limit   | $f_{MPXAMOUT} = 150$ kHz   | -   | 0    | -   | kHz        |
| $\Delta f_{USN(max)}$   | conversion range upper deviation limit   | $f_{MPXAMOUT} = 150$ kHz   | -   | 100  | -   | kHz        |
| $\Delta f_{USN}$  | bit resolution   |  | -   | 6.25 | -   | kHz        |
| Wideband AM analog-to-digital converter (4-bit); see <a href="#">Figure 24</a>      |  |  |     |      |     |            |
| $V_{WAM(min)(p-p)}$   | lower voltage limit of conversion range (peak-to-peak value)                                     | $f_{LEVEL} = 21$ kHz   | -   | 0    | -   | mV         |
| $V_{WAM(max)(p-p)}$   | upper voltage limit of conversion range (peak-to-peak value)                                     | $f_{LEVEL} = 21$ kHz   | -   | 800  | -   | mV         |
| $\Delta V_{WAM(p-p)}$   | bit resolution voltage (peak-to-peak value)  |  | -   | 53.3 | -   | mV         |
| <b>Tone/volume control</b>  |  |  |     |      |     |            |
| $Z_i$   | input impedance  | measured unbalanced; pins INAL, INAR, INAC, INBL, INBR, INC and IND            | 110 | 160  | -   | k $\Omega$ |
| $Z_o$   | output impedance   | pins LFOUT, RFOUT, LROUT and RROUT   | -   | -    | 100 | $\Omega$   |
| $G_{s(main)}$   | signal gain from pins INAL, INAR, INAC, INBL, INBR, INC and IND to LFOUT, RFOUT, LROUT and RROUT |  | -1  | -    | +1  | dB         |
| $V_{i(max)}$  | maximum input voltage  | THD = 0.2 %; $G_{vol} = -6$ dB; pins INAL, INAR, INAC, INBL, INBR, INC and IND | 2   | -    | -   | V          |

**Table 111. Dynamic characteristics of the sound processor ...continued**

$V_{CC} = 8.5\text{ V}$ ;  $T_{amb} = 25\text{ }^{\circ}\text{C}$ ; see [Figure 43](#); all AC values are given in RMS; treble: 10 kHz filter frequency; treble = 0 dB; bass: 60 Hz filter frequency; bass = 0 dB;  $f_{audio} = 1\text{ kHz}$ ;  $G_{vol} = 0\text{ dB}$ ;  $G_{fader} = 0\text{ dB}$ ; loudness off; standard output gain (byte OUTPUT; bit OUTA = 0);  $R_L = 10\text{ k}\Omega$ ;  $C_L = 1\text{ nF}$ ; unless otherwise specified.

| Symbol         | Parameter   | Conditions   | Min | Typ   | Max | Unit |
|----------------|---|--|-----|-------|-----|------|
| $V_{o(max)}$   | maximum output voltage  | $G_{vol} = +6\text{ dB}$   |     |       |     |      |
|                |   | THD = 0.2 %  | 1.4 | 1.8   | -   | V    |
|                |   | THD = 1 %; $R_L = 5\text{ k}\Omega$ ;<br>$C_L = 10\text{ nF}$  | 1.4 | 1.8   | -   | V    |
|                |   | $G_{vol} = +3\text{ dB}$ ;<br>OUTA = 1 (+3 dB)   |     |       |     |      |
|                |   | THD = 0.2 %  | 2   | 2.2   | -   | V    |
|                |   | THD = 0.2 %; $V_{CC} = 8.0\text{ V}$   | 1.6 | 1.8   | -   | V    |
|                |   | $R_L = 5\text{ k}\Omega$ ; $C_L = 10\text{ nF}$ ;<br>THD = 1 %   | 2   | 2.25  | -   | V    |
|                |   | $R_L = 5\text{ k}\Omega$ ; $C_L = 10\text{ nF}$ ;<br>THD = 1 %; $V_{CC} = 8.0\text{ V}$                                | 1.7 | 1.9   | -   | V    |
| $f_{max}$      | frequency response (pins INAL, INAR, INAC, INBL, INBR, INC and IND) | upper -1 dB point; referenced to 1 kHz   | 20  | -     | -   | kHz  |
| $\alpha_{ASI}$ | attenuation during ASI  | $f = 20\text{ kHz}$ referenced to 1 kHz  | -   | 0.15  | 1   | dB   |
| CMRR           | common mode rejection ratio   | $G_{vol} = 0\text{ dB}$ ; line input capacitance $C_i = 1\text{ }\mu\text{F}$  |     |       |     |      |
|                |   | $f_{audio} = 1\text{ kHz}$ on common mode inputs   | -   | 60    | -   | dB   |
|                |   | $f_{audio} = 20\text{ Hz}$ to 20 kHz on common mode inputs   | 40  | -     | -   | dB   |
| THD            | total harmonic distortion   | configured as non-inverting, single ended inputs   |     |       |     |      |
|                |   | $f_{audio} = 20\text{ Hz}$ to 10 kHz;<br>$V_i = 1\text{ V (RMS)}$  | -   | 0.02  | 0.1 | %    |
|                |   | $f_{audio} = 20\text{ Hz}$ to 10 kHz;<br>$V_i = 2\text{ V (RMS)}$ ;<br>$G_{vol} = -10\text{ dB}$                       | -   | 0.03  | 0.2 | %    |
|                |   | $f_{audio} = 25\text{ Hz}$ ;<br>$V_i = 500\text{ mV (RMS)}$ ;<br>$G_{bass} = +8\text{ dB}$ ; $G_{vol} = 0\text{ dB}$   | -   | 0.025 | 0.2 | %    |
|                |   | $f_{audio} = 4\text{ kHz}$ ;<br>$V_i = 500\text{ mV (RMS)}$ ;<br>$G_{treble} = +8\text{ dB}$ ; $G_{vol} = 0\text{ dB}$ | -   | 0.02  | 0.2 | %    |
| $\alpha_{cs}$  | channel separation  | $f_{audio} = 20\text{ Hz}$ to 20 kHz   | 60  | 75    | -   | dB   |
| $\alpha_S$     | input isolation of one selected source to any other input           | source impedance of unused input: 600 $\Omega$   |     |       |     |      |
|                |   | $f_{audio} = 20\text{ Hz}$ to 10 kHz   | 75  | 90    | -   | dB   |
|                |   | $f_{audio} = 20\text{ kHz}$  | 70  | -     | -   | dB   |

**Table 111. Dynamic characteristics of the sound processor ...continued**

$V_{CC} = 8.5\text{ V}$ ;  $T_{amb} = 25\text{ °C}$ ; see [Figure 43](#); all AC values are given in RMS; treble: 10 kHz filter frequency; treble = 0 dB; bass: 60 Hz filter frequency; bass = 0 dB;  $f_{audio} = 1\text{ kHz}$ ;  $G_{vol} = 0\text{ dB}$ ;  $G_{fader} = 0\text{ dB}$ ; loudness off; standard output gain (byte OUTPUT; bit OUTA = 0);  $R_L = 10\text{ k}\Omega$ ;  $C_L = 1\text{ nF}$ ; unless otherwise specified.

| Symbol            | Parameter   | Conditions  | Min                 | Typ | Max  | Unit          |    |
|-------------------|---|---|---------------------|-----|------|---------------|----|
| $V_{noise(rms)}$  | noise voltage (RMS value)                                       | CCIR-ARM weighted and 20 kHz 'brick wall' without input signal (source impedance 600 $\Omega$ ); unbalanced                             |                     |     |      |               |    |
|                   |   | $G_{vol} = 0\text{ dB}$   | -                   | 12  | 20   | $\mu\text{V}$ |    |
|                   |   | $G_{bass} = +6\text{ dB}$ ;<br>$G_{treble} = +6\text{ dB}$ ; $G_{vol} = 0\text{ dB}$  | -                   | 24  | 35   | $\mu\text{V}$ |    |
|                   |   | $G_{vol} = +20\text{ dB}$   | -                   | 71  | 100  | $\mu\text{V}$ |    |
|                   |   | $G_{vol} = +20\text{ dB}$ ; balanced  | -                   | 100 | 140  | $\mu\text{V}$ |    |
|                   |   | $G_{vol} = -10\text{ dB}$   | -                   | 10  | 18   | $\mu\text{V}$ |    |
|                   |   | $G_{vol} = -40\text{ dB}$   | -                   | 9.5 | 13.5 | $\mu\text{V}$ |    |
|                   |   | outputs muted<br>using 'A-weighting' filter and 20 kHz 'brick wall';<br>$G_{vol} = -20\text{ dB}$ ; start of loudness = $-12\text{ dB}$ | -                   | 6.8 | 10   | $\mu\text{V}$ |    |
| $V_{offset(max)}$ | maximum DC offset   | between any two settings (non-consecutive) on any one audio control   | -                   | 7   | -    | mV            |    |
|                   |   | between any two settings (non-consecutive) on volume control; $G_{vol} \leq +6\text{ dB}$   | -                   | 7   | -    | mV            |    |
|                   |   | between any two settings (non-consecutive) on input gain control; $G_{ing} \leq +6\text{ dB}$   | -                   | 7   | -    | mV            |    |
| PSRR              | power supply ripple rejection                                   | $V_{CC(AC)} = V_{ripple} = 200\text{ mV}$ (RMS); $G_{vol} = 0\text{ dB}$  |                     |     |      |               |    |
|                   |   | $f_{ripple} = 20\text{ Hz to }100\text{ Hz}$  | 35                  | 65  | -    | dB            |    |
|                   |   | $f_{ripple} = 100\text{ Hz to }1\text{ kHz}$  | 50                  | 70  | -    | dB            |    |
|                   |   | $f_{ripple} = 1\text{ kHz to }20\text{ kHz}$  | 30                  | 50  | -    | dB            |    |
|                   |   | $f_{ripple} = 500\text{ Hz}$  | -                   | 70  | -    | dB            |    |
| $\alpha_{ct}$     | crosstalk between bus inputs and signal outputs                 | $f_{clk} = 100\text{ kHz}$  | <a href="#">[2]</a> | -   | 110  | -             | dB |
| $t_d$             | delay time from $V_{CC}$ applied to final DC voltage at outputs |   | -                   | 12  | -    | ms            |    |
| <b>Input gain</b> |   |   |                     |     |      |               |    |
| $G_{ing}$         | input gain control  | see <a href="#">Table 76</a>  |                     |     |      |               |    |
|                   |   | maximum setting   | <a href="#">[3]</a> | -   | 18   | -             | dB |
|                   |   | minimum setting   | <a href="#">[3]</a> | -   | -10  | -             | dB |
| $G_{step(vol)}$   | step resolution   |   | -                   | 2   | -    | dB            |    |

**Table 111. Dynamic characteristics of the sound processor ...continued**

$V_{CC} = 8.5\text{ V}$ ;  $T_{amb} = 25\text{ °C}$ ; see [Figure 43](#); all AC values are given in RMS; treble: 10 kHz filter frequency; treble = 0 dB; bass: 60 Hz filter frequency; bass = 0 dB;  $f_{audio} = 1\text{ kHz}$ ;  $G_{vol} = 0\text{ dB}$ ;  $G_{fader} = 0\text{ dB}$ ; loudness off; standard output gain (byte OUTPUT; bit OUTA = 0);  $R_L = 10\text{ k}\Omega$ ;  $C_L = 1\text{ nF}$ ; unless otherwise specified.

| Symbol   | Parameter                                     | Conditions  | Min | Typ  | Max | Unit |    |
|--|---|---|-----|------|-----|------|----|
| <b>Volume</b>  |   |   |     |      |     |      |    |
| $G_{vol}$  | volume/balance gain control                   | see <a href="#">Table 83</a>  |     |      |     |      |    |
|  |   | maximum setting   | [3] | -    | 20  | -    | dB |
|  |   | minimum setting   | [3] | -    | -75 | -    | dB |
|  |   | mute attenuation;<br>20 Hz to 20 kHz  |     | -    | -90 | -80  | dB |
| $G_{step(vol)}$  | step resolution                               |   | -   | 1    | -   | dB   |    |
| $ \Delta G_{set} $   | gain set error                                | $G_{vol} = +20\text{ dB to }-35\text{ dB}$  | -   | 0.25 | 1   | dB   |    |
|  |   | $G_{vol} = -36\text{ dB to }-75\text{ dB}$  | -   | 0.55 | 3   | dB   |    |
| $\Delta G_{step(vol)}$   | gain step error                               |   | -   | -    | 1   | dB   |    |
| $ \Delta G_{track} $   | gain tracking error<br>between left and right | $G_{vol} = +20\text{ dB to }-35\text{ dB}$  | -   | 0.1  | 1   | dB   |    |
|  |   | $G_{vol} = -36\text{ dB to }-75\text{ dB}$  | -   | 0.3  | 3   | dB   |    |
| <b>Loudness; see <a href="#">Table 100</a> and <a href="#">Figure 39</a></b> |   |   |     |      |     |      |    |
| $G_{bass}$   | loudness bass control range                   |   | [4] | -    | 20  | -    | dB |
| $G_{treble}$   | loudness treble control range                 |   | -   | 4    | -   | dB   |    |
| $G_{step}$   | loudness step resolution                      |   | -   | 2    | -   | dB   |    |
| <b>Treble</b>  |   |   |     |      |     |      |    |
| $f_{treble}$   | treble control filter frequency               | see <a href="#">Figure 37</a> ; -3 dB frequency of maximum treble setting referenced to 100 kHz |     |      |     |      |    |
|  |   | TRF[1:0] = 00   | -   | 8    | -   | kHz  |    |
|  |   | TRF[1:0] = 01   | -   | 10   | -   | kHz  |    |
|  |   | TRF[1:0] = 10   | -   | 12   | -   | kHz  |    |
|  |   | TRF[1:0] = 11   | -   | 15   | -   | kHz  |    |
| $G_{treble}$   | treble gain control                           | TRE[2:0] = 111; TREM = 1  | -   | 14   | -   | dB   |    |
|  |   | TRE[2:0] = 111; TREM = 0  | -   | -14  | -   | dB   |    |
| $G_{step(treble)}$   | step resolution gain                          |   | -   | 2    | -   | dB   |    |
| $\Delta G_{step(treble)}$  | treble step error                             |   | -   | -    | 0.5 | dB   |    |
| <b>Bass</b>  |   |   |     |      |     |      |    |
| $f_{bass}$   | bass control filter frequency at maximum gain | see <a href="#">Figure 26</a>   |     |      |     |      |    |
|  |   | BAF[1:0] = 00   | -   | 60   | -   | Hz   |    |
|  |   | BAF[1:0] = 01   | -   | 80   | -   | Hz   |    |
|  |   | BAF[1:0] = 10   | -   | 100  | -   | Hz   |    |
|  | BAF[1:0] = 11                                 | -   | 120 | -    | Hz  |      |    |
| $G_{bass}$   | bass gain control                             | BAS[3:0] = 0111; BAM = 1  | -   | 14   | -   | dB   |    |
|  |   | BAS[3:0] = 0111; BAM = 0  | -   | -14  | -   | dB   |    |
| $G_{step(bass)}$   | step resolution gain                          |   | -   | 2    | -   | dB   |    |
| $\Delta G_{step(bass)}$  | bass step error                               |   | -   | -    | 0.5 | dB   |    |

**Table 111. Dynamic characteristics of the sound processor ...continued**

$V_{CC} = 8.5\text{ V}$ ;  $T_{amb} = 25\text{ °C}$ ; see [Figure 43](#); all AC values are given in RMS; treble: 10 kHz filter frequency; treble = 0 dB; bass: 60 Hz filter frequency; bass = 0 dB;  $f_{audio} = 1\text{ kHz}$ ;  $G_{vol} = 0\text{ dB}$ ;  $G_{fader} = 0\text{ dB}$ ; loudness off; standard output gain (byte OUTPUT; bit OUTA = 0);  $R_L = 10\text{ k}\Omega$ ;  $C_L = 1\text{ nF}$ ; unless otherwise specified.

| Symbol                   | Parameter            | Conditions   | Min | Typ | Max | Unit |
|--------------------------|----------------------|--|-----|-----|-----|------|
| $EQ_{bow}$               | equalizer bowing     | $f_{audio} = 1\text{ kHz}$ ;<br>$V_i = 500\text{ mV (RMS)}$ ;<br>$G_{bass} = +12\text{ dB}$ ; $f_{bass} = 60\text{ Hz}$ ;<br>$G_{treble} = +12\text{ dB}$ ;<br>$f_{cut(treble)} = 15\text{ kHz}$ | -   | 1.8 | -   | dB   |
| <b>Fader</b>             |                      |  |     |     |     |      |
| $G_{fader}$              | fader gain control   | see <a href="#">Table 91</a>   |     |     |     |      |
|                          |                      | maximum setting  | -   | 0   | -   | dB   |
|                          |                      | minimum setting  | -   | -64 | -   | dB   |
|                          |                      | output mute  | -   | -   | -80 | dB   |
| $G_{step(fader)}$        | step resolution gain |  | -   | 1   | -   | dB   |
| $\Delta G_{step(fader)}$ | fader step error     |  | -   | -   | 1   | dB   |
| $\alpha_{mute}$          | audio mute           | volume control: mute and output muted (bits MULF, MURF, MULR and MURR)   | 80  | 90  | -   | dB   |

- [1] The equivalent level voltage is that value of the level voltage (on pin LEVEL) which results in the same weak signal control effect (for instance HCC roll-off) as the output value of the specified detector (USN, WAM and MPH).
- [2] Crosstalk between bus inputs and signal outputs:  $\alpha_{ct} = 20 \log \frac{V_{bus(p-p)}}{V_{o(rms)}}$
- [3] The input gain setting ING and the volume setting VOL define the overall volume. The overall range is limited to -83 dB to +28 dB. For values > +28 dB the actual value is +28 dB. For overall values < -83 dB the actual value is mute.
- [4] The maximum bass gain including BASS setting is +20 dB.

### 13. I<sup>2</sup>C-bus characteristics

The maximum I<sup>2</sup>C-bus communication speed is 400 kbit/s. SDA and SCL HIGH and LOW internal thresholds are specified according to an I<sup>2</sup>C-bus voltage range from 2.5 V to 3.3 V including I<sup>2</sup>C-bus voltage tolerances of 10 %. The bus interface tolerates also SDA and SCL signals from a 5 V bus. Restrictions for  $V_{IL}$  in a 5 V application can be derived from [Table 112](#).

**Table 112. I<sup>2</sup>C-bus parameters**

| Symbol    | Parameter                | Conditions | Min  | Typ | Max  | Unit |
|-----------|--------------------------|------------|------|-----|------|------|
| $V_{IL}$  | LOW-level input voltage  |            | -    | -   | 1.09 | V    |
| $V_{IH}$  | HIGH-level input voltage |            | 1.56 | -   | -    | V    |
| $C_{SDA}$ | capacitance of SDA pin   |            | -    | 4   | 6    | pF   |
| $C_{SCL}$ | capacitance of SCL pin   |            | -    | 3   | 5    | pF   |

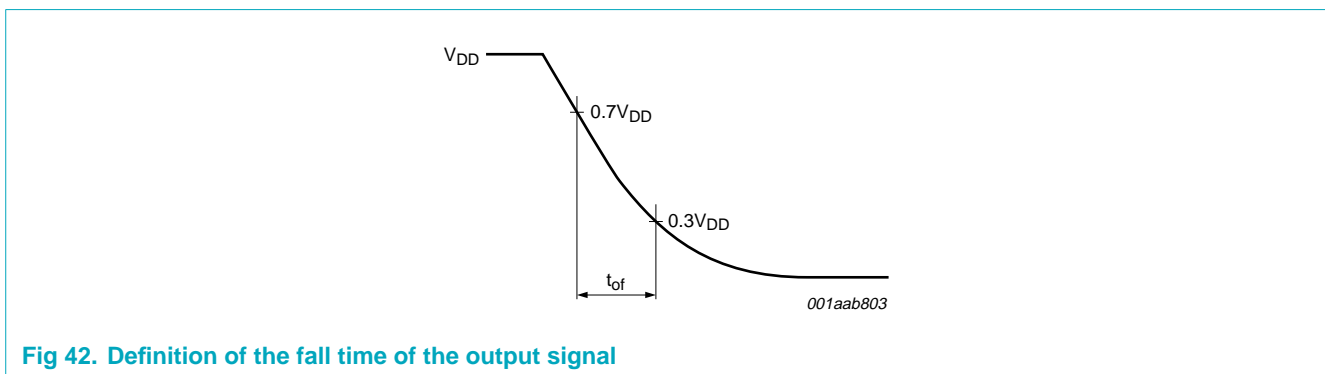
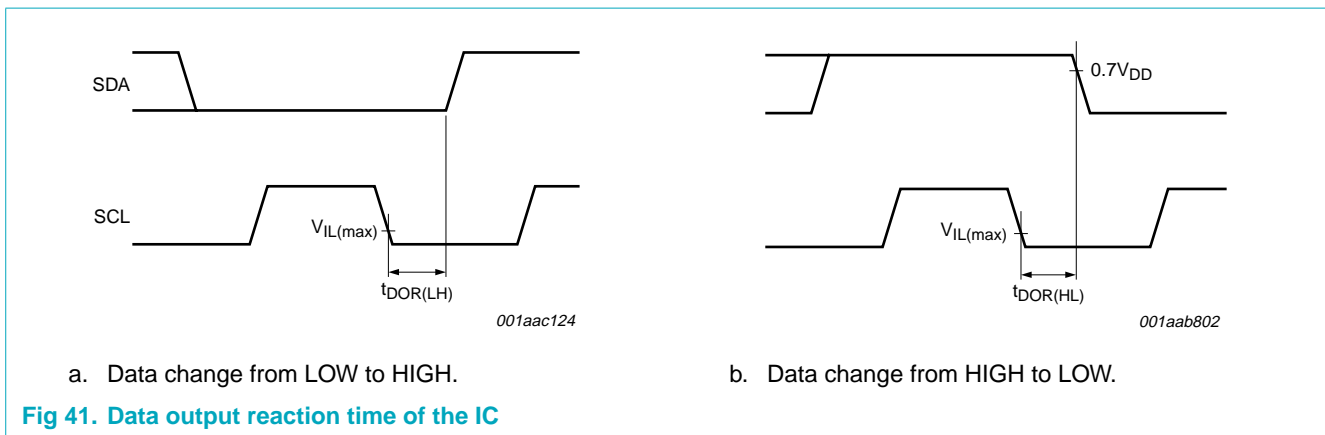

Table 112. I<sup>2</sup>C-bus parameters ...continued

| Symbol               | Parameter   | Conditions   | Min                           | Typ                  | Max | Unit |
|----------------------|---|--|-------------------------------|----------------------|-----|------|
| t <sub>DOR(HL)</sub> | data output reaction time (acknowledge and read data) HIGH-to-LOW | V <sub>DD</sub> = 5 V; I = 3 mA; C <sub>b</sub> = 400 pF; see Figure 41                  | -                             | 700                  | 863 | ns   |
|                      |   | V <sub>DD</sub> = 3.3 V; R <sub>p</sub> = 1.8 kΩ; C <sub>b</sub> = 400 pF; see Figure 41 | -                             | 570                  | 668 | ns   |
|                      |   | V <sub>DD</sub> = 2.5 V; R <sub>p</sub> = 35 kΩ; C <sub>b</sub> = 10 pF; see Figure 41   | -                             | 520                  | 593 | ns   |
| t <sub>DOR(LH)</sub> | data output reaction time (read data) LOW-to-HIGH                 | see Figure 41  | -                             | 450                  | 488 | ns   |
| t <sub>of</sub>      | output fall time  | C <sub>b</sub> = 10 pF to 120 pF; see Figure 42  | [1] 20 + 0.1C <sub>b</sub>    | 10 × V <sub>DD</sub> | -   | ns   |
|                      |   | C <sub>b</sub> ≥ 120 pF; see Figure 42   | [1][2] 20 + 0.1C <sub>b</sub> | -                    | 250 | ns   |

[1] Minimum value of t<sub>of</sub>; C<sub>b</sub> = total capacitance of one I<sup>2</sup>C-bus line [pF].

[2] Typical value of t<sub>of</sub>; the output fall time t<sub>of</sub> [ns] depends on the total load capacitance C<sub>b</sub> [pF] and the I<sup>2</sup>C-bus voltage V<sub>DD</sub> [V]:  
 $t_{of} = \frac{1}{12} \times V_{DD} \times C_b$ .



## 14. Overall system parameters

Table 113. Overall system parameters

| Symbol                              | Parameter  | Conditions  | Min | Typ | Max  | Unit       |
|-------------------------------------|--|---|-----|-----|------|------------|
| <b>Supply current in FM mode</b>    |  |   |     |     |      |            |
| $I_{CC}$                            | total supply current inclusive $I_{V60}$                         |   | -   | 102 | -    | mA         |
| <b>Supply current in AM mode</b>    |  |   |     |     |      |            |
| $I_{CC}$                            | total supply current inclusive $I_{V60}$                         |   | -   | 89  | -    | mA         |
| <b>AM overall system parameters</b> |  |   |     |     |      |            |
| $f_{tune}$                          | AM tuning frequency  | LW  | 144 | -   | 288  | kHz        |
|                                     |  | MW  | 522 | -   | 1710 | kHz        |
|                                     |  | SW  | 2.3 | -   | 26.1 | MHz        |
| $V_{sens}$                          | sensitivity voltage  | $f_{RF} = 990$ kHz; $m = 0.3$ ;<br>$f_{mod} = 1$ kHz;<br>$B_{AF} = 2.15$ kHz;<br>$(S+N)/N = 26$ dB;<br>dummy aerial<br>15 pF/60 pF                        | -   | 50  | -    | $\mu$ V    |
| S/N                                 | ultimate signal-to-noise ratio                                   |   | 54  | 58  | -    | dB         |
| THD                                 | total harmonic distortion  | $200 \mu$ V < $V_{RF}$ < 1 V;<br>$m = 0.8$ ; $f_{AF} = 400$ Hz  | -   | 0.4 | 1    | %          |
| IP3                                 | 3rd-order intercept point  | $\Delta f = 40$ kHz   | -   | 130 | -    | dB $\mu$ V |
| <b>FM overall system parameters</b> |  |   |     |     |      |            |
| $f_{tune}$                          | FM tuning frequency  |   | 65  | -   | 108  | MHz        |
| $V_{sens}$                          | sensitivity voltage (RF input voltage at $(S+N)/N = 26$ dB)      | $\Delta f = 22.5$ kHz;<br>$f_{mod} = 1$ kHz;<br>DEMP = 1; B = 300 Hz to 22 kHz; measured with 75 $\Omega$ dummy antenna and test circuit                  | -   | 2   | -    | $\mu$ V    |
| (S+N)/N                             | maximum signal plus noise-to-noise ratio of MPXAM output voltage | $V_i = 3$ mV;<br>$\Delta f = 22.5$ kHz;<br>$f_{mod} = 1$ kHz;<br>DEMP = 1; B = 300 Hz to 22 kHz; measured with 75 $\Omega$ dummy antenna and test circuit | -   | 60  | -    | dB         |
| THD                                 | total harmonic distortion  | $\Delta f = 75$ kHz   | -   | 0.5 | 1    | %          |
| IP3                                 | 3rd-order intercept point  | $\Delta f = 400$ kHz  | -   | 120 | -    | dB $\mu$ V |

15. Application information

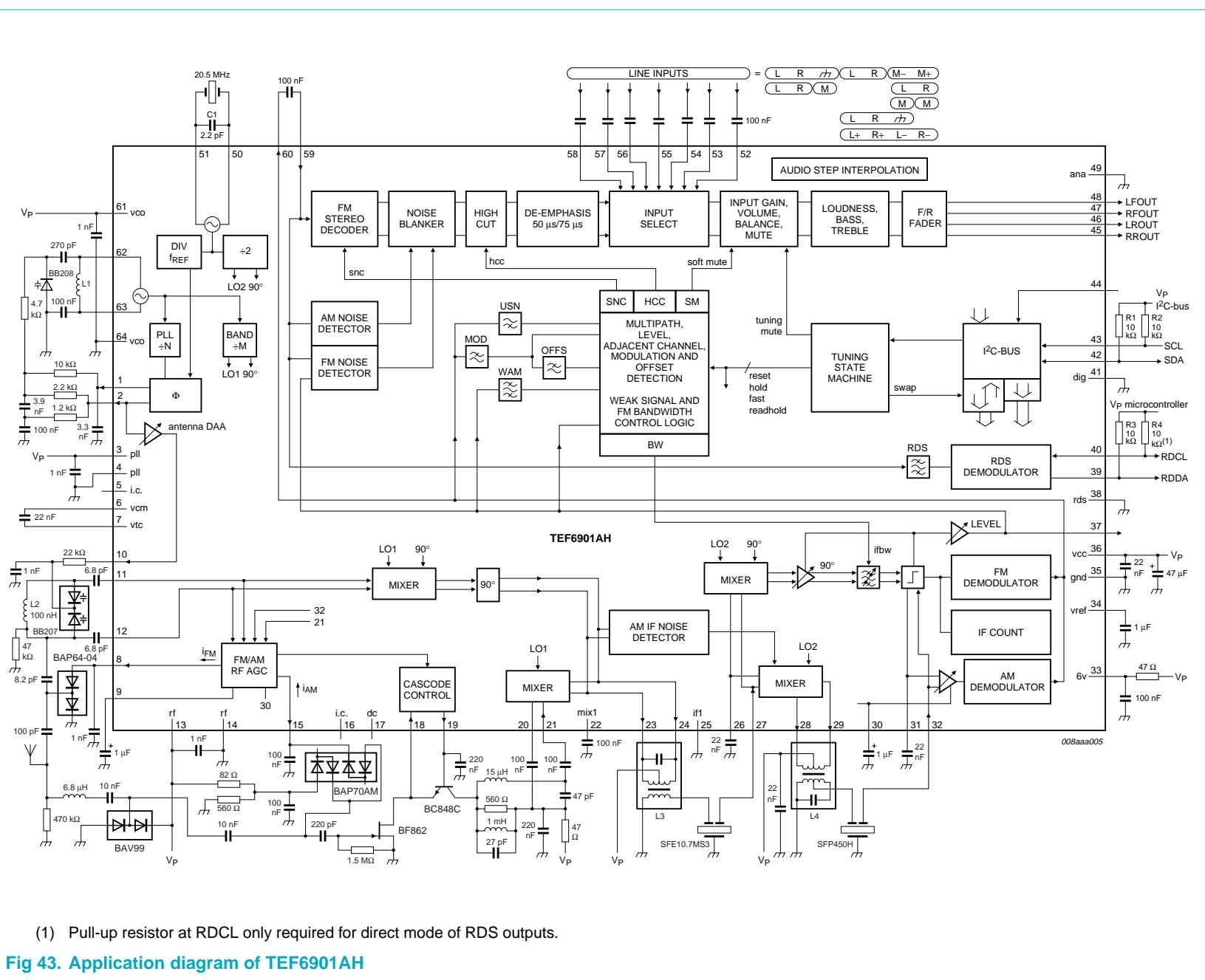

Fig 43. Application diagram of TEF6901AH

Table 114. List of components<sup>[1]</sup>

| Symbol | Component                                      | Type                  | Manufacturer |
|--------|--|-----------------------|--------------|
| C1     | capacitor for frequency pulling                | 2.2 pF <sup>[2]</sup> | -            |
| C2     | capacitor for VCO tuning                       | 270 pF                | -            |
| C3     | decoupling capacitor for VCO tuning            | 1 nF                  | -            |
| R1     | resistor for supply V60                        | 47 Ω; 0.2 W           | -            |
| L1     | oscillator coil                                | E543SNAS-02010        | TOKO         |
| L2     | FM RF selectivity coil                         | C6342A-R11            | SAGAMI       |
| L3     | 10.7 MHz IF transformer                        | PF670CCS-A065DX       | TOKO         |
| L4     | 450 kHz IF transformer                         | P7PSGAE-A021YBY=S     | TOKO         |
| X1     | crystal 20.5 MHz                               | LN-G102-587           | NDK          |
| D1     | VCO varactor diode                             | BB208                 | Philips      |
| D2     | RF selectivity varactor diode                  | BB207                 | Philips      |
| D3     | FM PIN diode                                   | BAP64-04              | Philips      |
| D4     | AM PIN diode                                   | BAP70AM               | Philips      |
| D5     | Electrostatic Discharge (ESD) protection diode | BAV99                 | Philips      |
| T1     | AM Low Noise Amplifier (LNA) JFET transistor   | BF862                 | Philips      |
| T2     | AM LNA cascode transistor                      | BC847C                | Philips      |
| F1     | 10.7 MHz ceramic filter                        | SFELA10M7HAA0-B0      | MURATA       |
| F2     | 450 kHz ceramic filter                         | CFWLA450KGFA-B0       | MURATA       |

[1] All low value capacitors ( $\leq 1$  nF) must be of NP0 type for guaranteed high frequency performance.

[2] The capacitor is used to achieve a crystal frequency of 20.5 MHz together with the crystal type LN-G102-587.

16. Package outline

QFP64: plastic quad flat package; 64 leads (lead length 1.6 mm); body 14 x 14 x 2.7 mm

SOT393-1

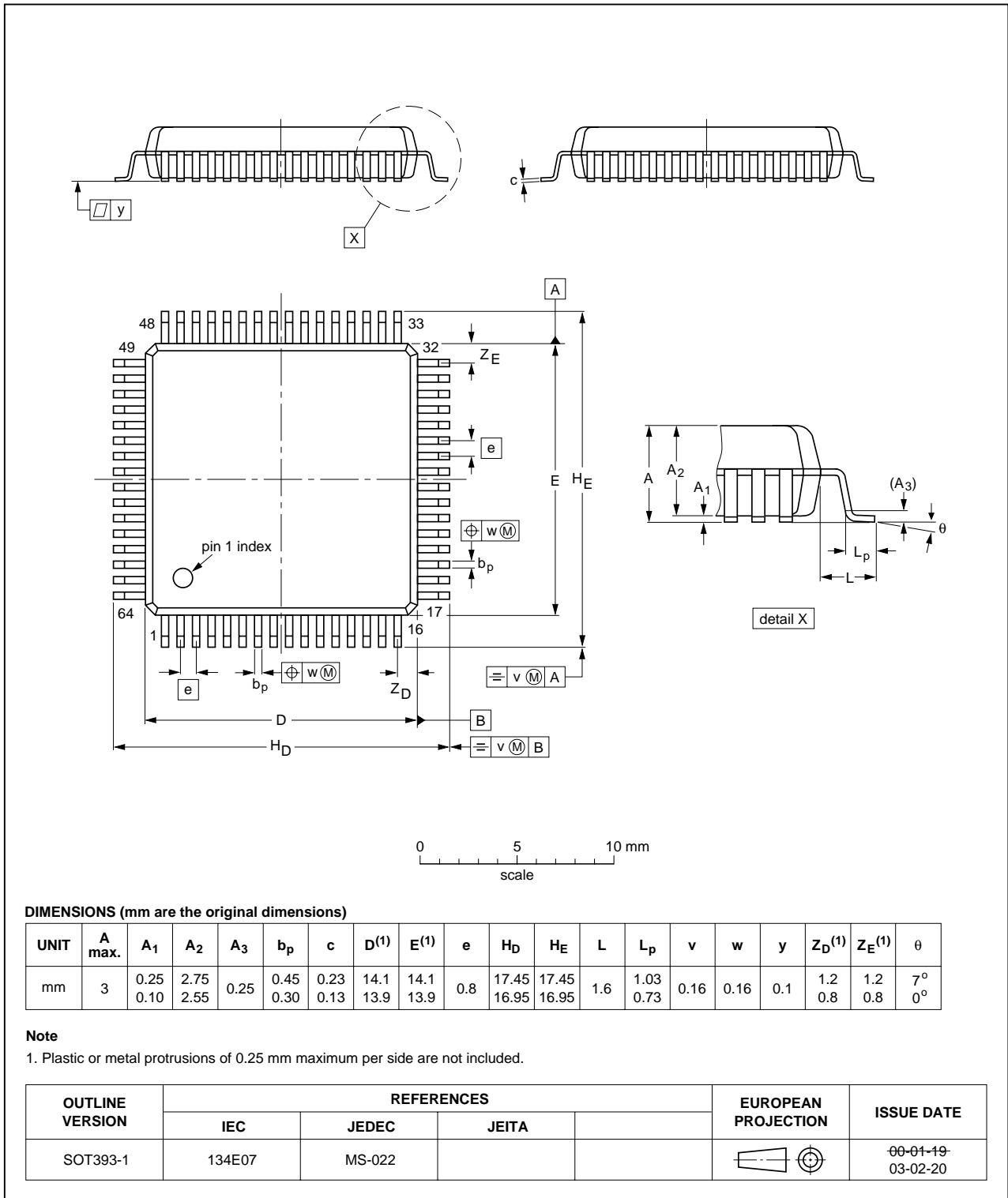

Fig 44. Package outline SOT393-1 (QFP64)

## 17. Soldering

### 17.1 Introduction to soldering surface mount packages

There is no soldering method that is ideal for all surface mount IC packages. Wave soldering can still be used for certain surface mount ICs, but it is not suitable for fine pitch SMDs. In these situations reflow soldering is recommended.

### 17.2 Reflow soldering

Reflow soldering requires solder paste (a suspension of fine solder particles, flux and binding agent) to be applied to the printed-circuit board by screen printing, stencilling or pressure-syringe dispensing before package placement. Driven by legislation and environmental forces the worldwide use of lead-free solder pastes is increasing.

Several methods exist for reflowing; for example, convection or convection/infrared heating in a conveyor type oven. Throughput times (preheating, soldering and cooling) vary between 100 seconds and 200 seconds depending on heating method.

Typical reflow temperatures range from 215 °C to 260 °C depending on solder paste material. The peak top-surface temperature of the packages should be kept below:

**Table 115. SnPb eutectic process - package peak reflow temperatures (from J-STD-020C July 2004)**

| Package thickness | Volume mm <sup>3</sup> < 350 | Volume mm <sup>3</sup> ≥ 350 |
|-------------------|------------------------------|------------------------------|
| < 2.5 mm          | 240 °C + 0/-5 °C             | 225 °C + 0/-5 °C             |
| ≥ 2.5 mm          | 225 °C + 0/-5 °C             | 225 °C + 0/-5 °C             |

**Table 116. Pb-free process - package peak reflow temperatures (from J-STD-020C July 2004)**

| Package thickness | Volume mm <sup>3</sup> < 350 | Volume mm <sup>3</sup> 350 to 2000 | Volume mm <sup>3</sup> > 2000 |
|-------------------|------------------------------|------------------------------------|-------------------------------|
| < 1.6 mm          | 260 °C + 0 °C                | 260 °C + 0 °C                      | 260 °C + 0 °C                 |
| 1.6 mm to 2.5 mm  | 260 °C + 0 °C                | 250 °C + 0 °C                      | 245 °C + 0 °C                 |
| ≥ 2.5 mm          | 250 °C + 0 °C                | 245 °C + 0 °C                      | 245 °C + 0 °C                 |

Moisture sensitivity precautions, as indicated on packing, must be respected at all times.

### 17.3 Wave soldering

Conventional single wave soldering is not recommended for surface mount devices (SMDs) or printed-circuit boards with a high component density, as solder bridging and non-wetting can present major problems.

To overcome these problems the double-wave soldering method was specifically developed.

If wave soldering is used the following conditions must be observed for optimal results:

- Use a double-wave soldering method comprising a turbulent wave with high upward pressure followed by a smooth laminar wave.
- For packages with leads on two sides and a pitch (e):

- larger than or equal to 1.27 mm, the footprint longitudinal axis is **preferred** to be parallel to the transport direction of the printed-circuit board;
- smaller than 1.27 mm, the footprint longitudinal axis **must** be parallel to the transport direction of the printed-circuit board.

The footprint must incorporate solder thieves at the downstream end.

- For packages with leads on four sides, the footprint must be placed at a 45° angle to the transport direction of the printed-circuit board. The footprint must incorporate solder thieves downstream and at the side corners.

During placement and before soldering, the package must be fixed with a droplet of adhesive. The adhesive can be applied by screen printing, pin transfer or syringe dispensing. The package can be soldered after the adhesive is cured.

Typical dwell time of the leads in the wave ranges from 3 seconds to 4 seconds at 250 °C or 265 °C, depending on solder material applied, SnPb or Pb-free respectively.

A mildly-activated flux will eliminate the need for removal of corrosive residues in most applications.

### 17.4 Manual soldering

Fix the component by first soldering two diagonally-opposite end leads. Use a low voltage (24 V or less) soldering iron applied to the flat part of the lead. Contact time must be limited to 10 seconds at up to 300 °C.

When using a dedicated tool, all other leads can be soldered in one operation within 2 seconds to 5 seconds between 270 °C and 320 °C.

### 17.5 Package related soldering information

Table 117. Suitability of surface mount IC packages for wave and reflow soldering methods

| Package <sup>[1]</sup>   | Soldering method                  |                       |
|--|-----------------------------------|-----------------------|
|  | Wave                              | Reflow <sup>[2]</sup> |
| BGA, HTSSON..T <sup>[3]</sup> , LBGA, LFBGA, SQFP, SSOP..T <sup>[3]</sup> , TFBGA, VFBGA, XSON | not suitable                      | suitable              |
| DHVQFN, HBCC, HBGA, HLQFP, HSO, HSOP, HSQFP, HSSON, HTQFP, HTSSOP, HVQFN, HVSON, SMS           | not suitable <sup>[4]</sup>       | suitable              |
| PLCC <sup>[5]</sup> , SO, SOJ  | suitable                          | suitable              |
| LQFP, QFP, TQFP  | not recommended <sup>[5][6]</sup> | suitable              |
| SSOP, TSSOP, VSO, VSSOP  | not recommended <sup>[7]</sup>    | suitable              |
| CWQCCN..L <sup>[8]</sup> , PMFP <sup>[9]</sup> , WQCCN..L <sup>[8]</sup>                       | not suitable                      | not suitable          |

[1] For more detailed information on the BGA packages refer to the *(LF)BGA Application Note* (AN01026); order a copy from your Philips Semiconductors sales office.

[2] All surface mount (SMD) packages are moisture sensitive. Depending upon the moisture content, the maximum temperature (with respect to time) and body size of the package, there is a risk that internal or external package cracks may occur due to vaporization of the moisture in them (the so called popcorn effect). For details, refer to the Drypack information in the *Data Handbook IC26; Integrated Circuit Packages; Section: Packing Methods*.

- [3] These transparent plastic packages are extremely sensitive to reflow soldering conditions and must on no account be processed through more than one soldering cycle or subjected to infrared reflow soldering with peak temperature exceeding  $217\text{ °C} \pm 10\text{ °C}$  measured in the atmosphere of the reflow oven. The package body peak temperature must be kept as low as possible.
- [4] These packages are not suitable for wave soldering. On versions with the heatsink on the bottom side, the solder cannot penetrate between the printed-circuit board and the heatsink. On versions with the heatsink on the top side, the solder might be deposited on the heatsink surface.
- [5] If wave soldering is considered, then the package must be placed at a  $45^\circ$  angle to the solder wave direction. The package footprint must incorporate solder thieves downstream and at the side corners.
- [6] Wave soldering is suitable for LQFP, QFP and TQFP packages with a pitch (e) larger than 0.8 mm; it is definitely not suitable for packages with a pitch (e) equal to or smaller than 0.65 mm.
- [7] Wave soldering is suitable for SSOP, TSSOP, VSO and VSSOP packages with a pitch (e) equal to or larger than 0.65 mm; it is definitely not suitable for packages with a pitch (e) equal to or smaller than 0.5 mm.
- [8] Image sensor packages in principle should not be soldered. They are mounted in sockets or delivered pre-mounted on flex foil. However, the image sensor package can be mounted by the client on a flex foil by using a hot bar soldering process. The appropriate soldering profile can be provided on request.
- [9] Hot bar soldering or manual soldering is suitable for PMFP packages.

## 18. Revision history

Table 118. Revision history

| Document ID    | Release date  | Data sheet status      | Change notice | Supersedes |
|----------------|---|------------------------|---------------|------------|
| TEF6901A_2     | 20060710  | Product data sheet     | -             | TEF6901A_1 |
| Modifications: | <ul style="list-style-type: none"> <li>• <a href="#">Table 22</a>: added row 1Fh</li> <li>• <a href="#">Section 8.2.27</a>: changed 1Fh to 1Eh in table titles</li> <li>• <a href="#">Section 8.2.28</a>: added</li> <li>• <a href="#">Table 110</a>: AM demodulator output pin MPXAMOUT specification: changed values of <math>V_o</math></li> <li>• <a href="#">Table 111</a>: stereo decoder and AM path specification: changed value of <math>V_{o(AM)}</math></li> </ul> |                        |               |            |
| TEF6901A_1     | 20060202  | Preliminary data sheet | -             | -          |



## 19. Legal information

### 19.1 Data sheet status

| Document status <sup>[1][2]</sup> | Product status <sup>[3]</sup> | Definition  |
|-----------------------------------|-------------------------------|---|
| Objective [short] data sheet      | Development                   | This document contains data from the objective specification for product development. |
| Preliminary [short] data sheet    | Qualification                 | This document contains data from the preliminary specification.                       |
| Product [short] data sheet        | Production                    | This document contains the product specification.                                     |

[1] Please consult the most recently issued document before initiating or completing a design.

[2] The term 'short data sheet' is explained in section "Definitions".

[3] The product status of device(s) described in this document may have changed since this document was published and may differ in case of multiple devices. The latest product status information is available on the Internet at URL <http://www.semiconductors.philips.com>.

### 19.2 Definitions

**Draft** — The document is a draft version only. The content is still under internal review and subject to formal approval, which may result in modifications or additions. Philips Semiconductors does not give any representations or warranties as to the accuracy or completeness of information included herein and shall have no liability for the consequences of use of such information.

**Short data sheet** — A short data sheet is an extract from a full data sheet with the same product type number(s) and title. A short data sheet is intended for quick reference only and should not be relied upon to contain detailed and full information. For detailed and full information see the relevant full data sheet, which is available on request via the local Philips Semiconductors sales office. In case of any inconsistency or conflict with the short data sheet, the full data sheet shall prevail.

### 19.3 Disclaimers

**General** — Information in this document is believed to be accurate and reliable. However, Philips Semiconductors does not give any representations or warranties, expressed or implied, as to the accuracy or completeness of such information and shall have no liability for the consequences of use of such information.

**Right to make changes** — Philips Semiconductors reserves the right to make changes to information published in this document, including without limitation specifications and product descriptions, at any time and without notice. This document supersedes and replaces all information supplied prior to the publication hereof.

**Suitability for use** — Philips Semiconductors products are not designed, authorized or warranted to be suitable for use in medical, military, aircraft, space or life support equipment, nor in applications where failure or malfunction of a Philips Semiconductors product can reasonably be expected

to result in personal injury, death or severe property or environmental damage. Philips Semiconductors accepts no liability for inclusion and/or use of Philips Semiconductors products in such equipment or applications and therefore such inclusion and/or use is at the customer's own risk.

**Applications** — Applications that are described herein for any of these products are for illustrative purposes only. Philips Semiconductors makes no representation or warranty that such applications will be suitable for the specified use without further testing or modification.

**Limiting values** — Stress above one or more limiting values (as defined in the Absolute Maximum Ratings System of IEC 60134) may cause permanent damage to the device. Limiting values are stress ratings only and operation of the device at these or any other conditions above those given in the Characteristics sections of this document is not implied. Exposure to limiting values for extended periods may affect device reliability.

**Terms and conditions of sale** — Philips Semiconductors products are sold subject to the general terms and conditions of commercial sale, as published at <http://www.semiconductors.philips.com/profile/terms>, including those pertaining to warranty, intellectual property rights infringement and limitation of liability, unless explicitly otherwise agreed to in writing by Philips Semiconductors. In case of any inconsistency or conflict between information in this document and such terms and conditions, the latter will prevail.

**No offer to sell or license** — Nothing in this document may be interpreted or construed as an offer to sell products that is open for acceptance or the grant, conveyance or implication of any license under any copyrights, patents or other industrial or intellectual property rights.

### 19.4 Trademarks

Notice: All referenced brands, product names, service names and trademarks are the property of their respective owners.

**I<sup>2</sup>C-bus** — logo is a trademark of Koninklijke Philips Electronics N.V.

## 20. Contact information

For additional information, please visit: <http://www.semiconductors.philips.com>

For sales office addresses, send an email to: [sales.addresses@www.semiconductors.philips.com](mailto:sales.addresses@www.semiconductors.philips.com)

**21. Contents**

|          |  |           |            |  |           |
|----------|--|-----------|------------|--|-----------|
| <b>1</b> | <b>General description</b> . . . . .                                     | <b>1</b>  | <b>8.1</b> | Read mode                                      | 13        |
| <b>2</b> | <b>Features</b> . . . . .  | <b>1</b>  | 8.1.1      | Read mode: data byte IFCOUNTER                 | 14        |
| <b>3</b> | <b>Quick reference data</b> . . . . .                                    | <b>2</b>  | 8.1.2      | Read mode: data byte LEVEL                     | 16        |
| <b>4</b> | <b>Ordering information</b> . . . . .                                    | <b>3</b>  | 8.1.3      | Read mode: data byte USN/WAM                   | 17        |
| <b>5</b> | <b>Block diagram</b> . . . . .   | <b>4</b>  | 8.1.4      | Read mode: data byte MOD                       | 18        |
| <b>6</b> | <b>Pinning information</b> . . . . .                                     | <b>5</b>  | 8.1.5      | Read mode: data byte IFBW                      | 20        |
| 6.1      | Pinning . . . . .  | 5         | 8.1.6      | Read mode: data byte ID                        | 20        |
| 6.2      | Pin description . . . . .  | 5         | 8.1.7      | Read mode: data byte TEMP                      | 21        |
| <b>7</b> | <b>Functional description</b> . . . . .                                  | <b>7</b>  | 8.2        | Write mode                                     | 21        |
| 7.1      | FM mixer 1 . . . . .   | 7         | 8.2.1      | Mode and subaddress byte for write             | 27        |
| 7.2      | FM RF AGC . . . . .  | 7         | 8.2.2      | Write mode: data byte BANDWIDTH                | 34        |
| 7.3      | FM mixer 2 . . . . .   | 7         | 8.2.3      | Write mode: data bytes PLLM and PLLL           | 36        |
| 7.4      | FM IF2 channel filter . . . . .  | 7         | 8.2.4      | Write mode: data byte DAA                      | 36        |
| 7.5      | FM limiter and level detection . . . . .                                 | 8         | 8.2.5      | Write mode: data byte AGC                      | 37        |
| 7.6      | FM demodulator . . . . .   | 8         | 8.2.6      | Write mode: data byte BAND                     | 38        |
| 7.7      | Center frequency and bandwidth tuning and center frequency DAA . . . . . | 8         | 8.2.7      | Tuning overview                                | 39        |
| 7.8      | Bandwidth control algorithm . . . . .                                    | 8         | 8.2.8      | Write mode: data byte LEVELALGN                | 40        |
| 7.9      | VCO and dividers . . . . .   | 8         | 8.2.9      | Write mode: data byte IFCF                     | 40        |
| 7.10     | Crystal oscillator . . . . .   | 8         | 8.2.10     | Write mode: data byte IFCAP                    | 40        |
| 7.11     | Tuning PLL . . . . .   | 8         | 8.2.10.1   | Factory alignment of bits IFCAP[3:0]           | 41        |
| 7.12     | Antenna DAA . . . . .  | 9         | 8.2.10.2   | Initialization of the radio                    | 41        |
| 7.13     | AM RF AGC control . . . . .  | 9         | 8.2.10.3   | Factory alignment of IFCF                      | 41        |
| 7.14     | AM mixer 1 . . . . .   | 9         | 8.2.11     | Write mode: data byte ACD                      | 42        |
| 7.15     | AM IF noise blanker . . . . .  | 9         | 8.2.12     | Write mode: data byte SENSE                    | 42        |
| 7.16     | AM IF AGC amplifier and demodulator . . . . .                            | 9         | 8.2.13     | Write mode: data byte TIMING                   | 44        |
| 7.17     | AM level detection . . . . .   | 9         | 8.2.14     | Write mode: data byte SNC                      | 45        |
| 7.18     | AM and FM level DAA . . . . .  | 9         | 8.2.15     | Write mode: data byte HIGHCUT                  | 47        |
| 7.19     | AM and FM IF counter . . . . .   | 9         | 8.2.16     | Write mode: data byte SOFTMUTE                 | 50        |
| 7.20     | Tuning mute . . . . .  | 9         | 8.2.17     | Write mode: data byte RADIO                    | 54        |
| 7.21     | FM stereo decoder . . . . .  | 10        | 8.2.18     | Write mode: data byte INPUT                    | 56        |
| 7.22     | FM and AM AF noise blanker . . . . .                                     | 10        | 8.2.19     | Write mode: data byte VOLUME                   | 58        |
| 7.23     | Fixed high cut and high cut control . . . . .                            | 10        | 8.2.20     | Write mode: data byte TREBLE                   | 65        |
| 7.24     | De-emphasis . . . . .  | 10        | 8.2.21     | Write mode: data byte BASS                     | 66        |
| 7.25     | Weak signal processing . . . . .   | 10        | 8.2.22     | Write mode: data byte FADER                    | 68        |
| 7.26     | Audio step interpolation . . . . .                                       | 11        | 8.2.23     | Write mode: data byte OUTPUT                   | 68        |
| 7.27     | Source selector . . . . .  | 11        | 8.2.24     | Write mode: data byte BALANCE                  | 69        |
| 7.28     | VU-meter read . . . . .  | 11        | 8.2.25     | Write mode: data byte LOUDNESS                 | 69        |
| 7.29     | Volume and balance . . . . .   | 11        | 8.2.26     | Write mode: data byte POWER                    | 72        |
| 7.30     | CD compression . . . . .   | 11        | 8.2.27     | Write mode: data bytes RESERVED                | 72        |
| 7.31     | Bass . . . . .   | 12        | 8.2.28     | Write mode: data byte TEST                     | 73        |
| 7.32     | Treble . . . . .   | 12        | <b>9</b>   | <b>Limiting values</b> . . . . .               | <b>73</b> |
| 7.33     | Loudness . . . . .   | 12        | <b>10</b>  | <b>Thermal characteristics</b> . . . . .       | <b>74</b> |
| 7.34     | Fader . . . . .  | 12        | <b>11</b>  | <b>Static characteristics</b> . . . . .        | <b>74</b> |
| 7.35     | RDS/RBDS demodulator . . . . .   | 12        | <b>12</b>  | <b>Dynamic characteristics</b> . . . . .       | <b>76</b> |
| <b>8</b> | <b>I<sup>2</sup>C-bus protocol</b> . . . . .                             | <b>12</b> | 12.1       | Dynamic characteristics of the tuner           | 76        |
|          |  |           | 12.2       | Dynamic characteristics of the sound processor | 85        |

continued >>

|           |  |            |
|-----------|--|------------|
| <b>13</b> | <b>I<sup>2</sup>C-bus characteristics</b> .....        | <b>96</b>  |
| <b>14</b> | <b>Overall system parameters</b> .....                 | <b>98</b>  |
| <b>15</b> | <b>Application information</b> .....                   | <b>99</b>  |
| <b>16</b> | <b>Package outline</b> .....                           | <b>101</b> |
| <b>17</b> | <b>Soldering</b> .....                                 | <b>102</b> |
| 17.1      | Introduction to soldering surface mount packages ..... | 102        |
| 17.2      | Reflow soldering .....                                 | 102        |
| 17.3      | Wave soldering .....                                   | 102        |
| 17.4      | Manual soldering .....                                 | 103        |
| 17.5      | Package related soldering information .....            | 103        |
| <b>18</b> | <b>Revision history</b> .....                          | <b>104</b> |
| <b>19</b> | <b>Legal information</b> .....                         | <b>105</b> |
| 19.1      | Data sheet status .....                                | 105        |
| 19.2      | Definitions .....                                      | 105        |
| 19.3      | Disclaimers .....                                      | 105        |
| 19.4      | Trademarks .....                                       | 105        |
| <b>20</b> | <b>Contact information</b> .....                       | <b>105</b> |
| <b>21</b> | <b>Contents</b> .....                                  | <b>106</b> |



Please be aware that important notices concerning this document and the product(s) described herein, have been included in section 'Legal information'.

© Koninklijke Philips Electronics N.V. 2006. All rights reserved.

For more information, please visit: <http://www.semiconductors.philips.com>.

For sales office addresses, email to: [sales.addresses@www.semiconductors.philips.com](mailto:sales.addresses@www.semiconductors.philips.com).

Date of release: 10 July 2006

Document identifier: TEF6901A\_2